

User Manual

AXPERT MLV 6KVA-48V INVERTER / CHARGER

Table of Contents

ABOUT THIS MANUAL	1
Purpose.....	1
Scope.....	1
SAFETY INSTRUCTIONS	1
INTRODUCTION	2
Features.....	2
Basic System Architecture	2
Product Overview.....	3
INSTALLATION	4
Unpacking and Inspection.....	4
Preparation	4
Mounting the Unit.....	4
Battery Connection	5
AC Input/Output Connection.....	7
PV Connection	9
Final Assembly.....	10
Communication Connection.....	10
Dry Contact Signal	10
OPERATION	11
Power ON/OFF	11
Operation and Display Panel	11
LCD Display Icons	12
LCD Setting.....	14
Display Setting	21
Operating Mode Description	24
Fault Reference Code.....	25
Warning Indicator.....	26
SPECIFICATIONS	27
Table 1: Line Mode Specifications.....	27
Table 2: Inverter Mode Specifications.....	28
Table 3: Charging Mode Specifications	28
Table 4 General Specifications	29
TROUBLESHOOTING	30
Appendix I: Approximate Back-up Time Table	31
Appendix II: Parallel function	32

ABOUT THIS MANUAL

Purpose

This manual describes the assembly, installation, operation and troubleshooting of this unit. Please read this manual carefully before installations and operations. Keep this manual for future reference.

Scope

This manual provides safety and installation guidelines as well as information on tools and wiring.

SAFETY INSTRUCTIONS



WARNING: This chapter contains important safety and operating instructions. Read and keep this manual for future reference.

1. Before using the unit, read all instructions and warnings marked on the unit, the batteries and all appropriate sections of this manual.
2. **CAUTION** --To reduce risk of injury, charge it with only deep-cycle lead acid type rechargeable batteries. It might cause burst or result in physical injury and damage if you charge it with other types of the batteries.
3. Do not disassemble the unit at will. For servicing or repairs, it's advised to take it to an authorized service center. Incorrect re-assembly may result in a risk of electric shock or fire.
4. To reduce the risk of electric shock, unplug all wirings from the wall outlet before any maintenance or cleaning. Turning off the unit will not reduce this risk.
5. **CAUTION** – Only qualified personnel can install this device with battery.
6. **NEVER** charge a frozen battery.
7. For optimum operation of this inverter/charger, please follow required spec to select appropriate cable size. It's very important to correctly operate this inverter/charger.
8. Be very cautious when working with metal tools on or around the batteries. A potential risk exists when you drop tools on or around the batteries. Spark, short circuited batteries or other electrical parts might cause an explosion.
9. Please strictly follow installation procedure when you want to disconnect AC or DC terminals. Please refer to the INSTALLATION section of this manual for the details.
10. Fuses are provided for over-current protection of the battery supply.
11. GROUNDING INSTRUCTIONS -This inverter/charger should be connected to a permanent grounded wiring system. Be sure to comply with local requirements and regulation to install this inverter.
12. NEVER cause AC output and DC input short circuited. Do NOT connect to the mains when DC input short circuits.
13. **Warning!!** Only qualified service staffs are able to operate this device. If errors still persist after following the troubleshooting table, please send this inverter/charger back to the local dealer or service center for maintenance.

INTRODUCTION

This is a multi-functional inverter/charger, combining the functions of inverter, MPPT solar charger and battery charger to offer uninterruptible power support with portability. Its comprehensive LCD display offers user-configurable and easy-accessible button operation such as battery charging current, priority setting for AC/solar charger, and acceptable input voltage setting to suit different applications.

Features

- Pure sine wave inverter
- Built-in MPPT solar charge controller
- Configurable input voltage range for home appliances and personal computers via LCD setting
- Configurable battery charging current to suit different applications via LCD setting
- Configurable priority of AC/Solar Charger via LCD setting
- Compatible to mains voltage or generator power
- Automatic restart while AC is recovering
- Overload/ Over temperature/ short circuit protection
- Smart battery charger design to optimize battery performance
- Cold start function

Basic System Architecture

The following illustration shows basic application of this inverter/charger. It also includes the following devices to complete the whole running system:

- Generator or Utility.
- PV modules

Consult your system integrator for other possible system architectures depending on your requirements.

This inverter can power all kinds of appliances at home or in the office, including motor-type appliances such as tube light, fan, refrigerator and air conditioner.

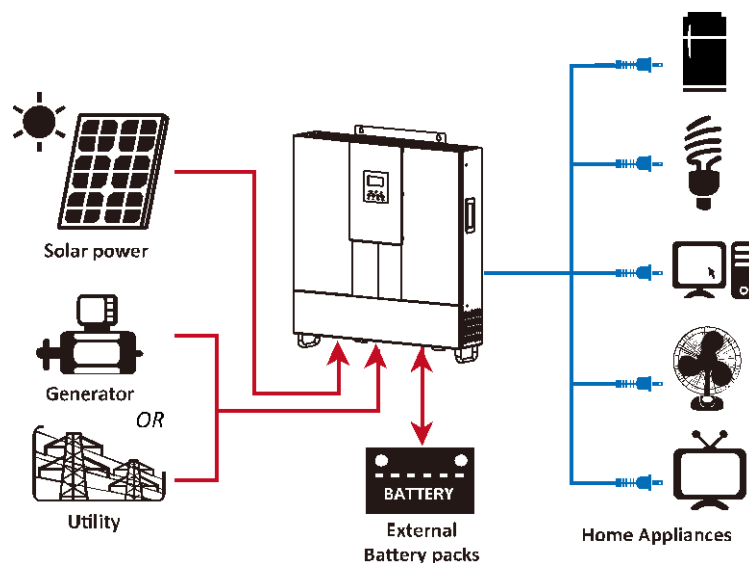
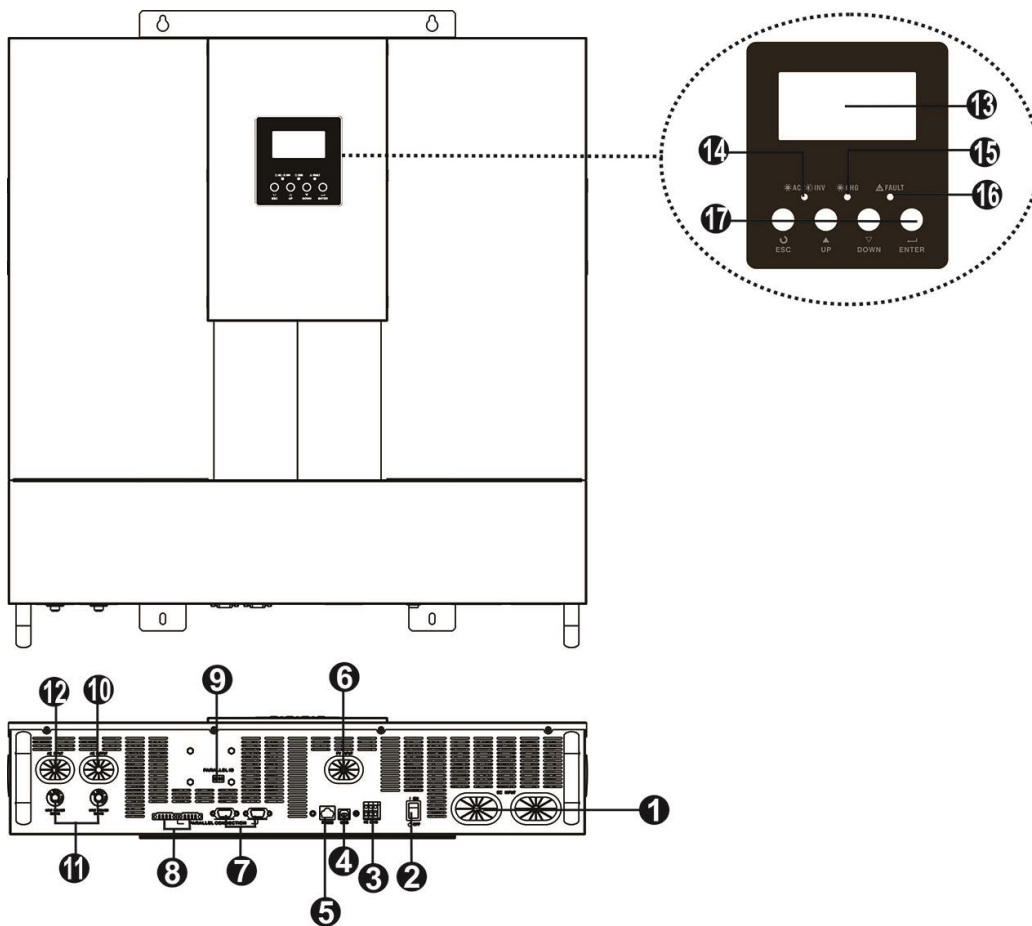

Figure 1 Hybrid Power System

Product Overview



1. Battery connector
2. Power on/off switch
3. Dry contact
4. USB communication port
5. RS232 communication port
6. PV input
7. Parallel communication port (only for parallel model)
8. Current sharing port (only for parallel model)
9. Parallel ID (Please check chapter 6 in Parallel Function for setting details.)
10. AC output
11. Circuit breaker
12. AC input
13. LCD display
14. Status indicator
15. Charging indicator
16. Fault indicator
17. Function buttons

INSTALLATION

Unpacking and Inspection

Before installation, please inspect the unit. Be sure that nothing inside the package is damaged. You should have received the following items inside the package:

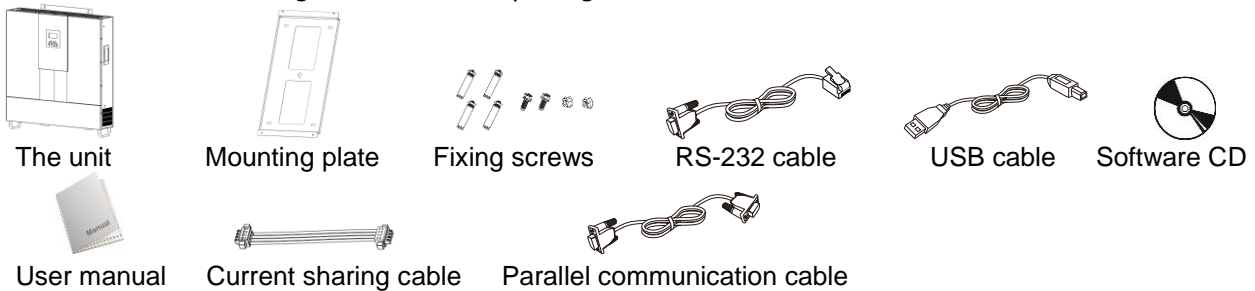

Preparation

Before connecting all wirings, please take off the cover of the bottom by removing the six screws as shown below.

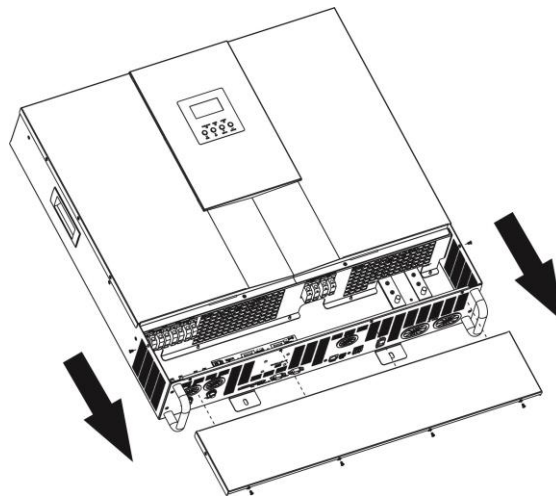

Mounting the Unit

Consider the following points before selecting where to install:

- Do not mount the inverter on any flammable construction materials.
- Mount this inverter on a solid surface
- Install this inverter at eye level in order to read the LCD display at all times.
- The ambient temperature should be between 0°C and 55°C to ensure optimal operation.
- The inverter should be adhered to the wall vertically.
- Be sure to keep other objects away and leave the space in a minimum as shown in the right diagram to guarantee sufficient heat dissipation and enough space for replacing wires.

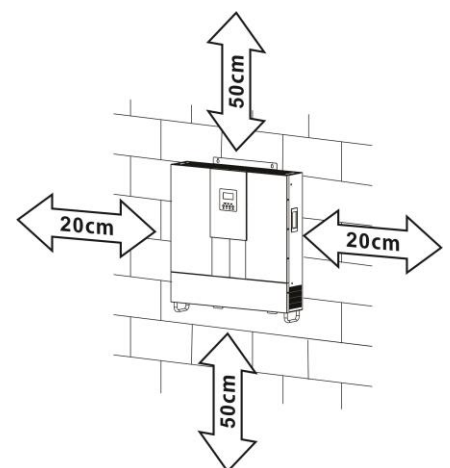

SUITABLE FOR MOUNTING ON CONCRETE OR OTHER NON-COMBUSTIBLE SURFACE ONLY.

Install the unit by screwing four screws as shown in the diagram.

It's recommended to use M5 screws.

1. Drill four holes in the marked locations with 4 screws. The reference tightening torque is 35 N.m.
2. Raise the inverter and place it over the mounting plate.

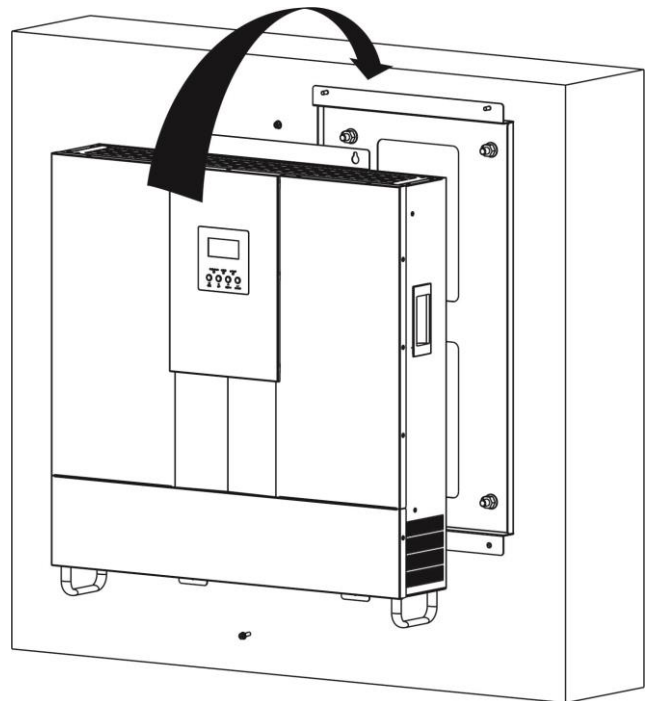
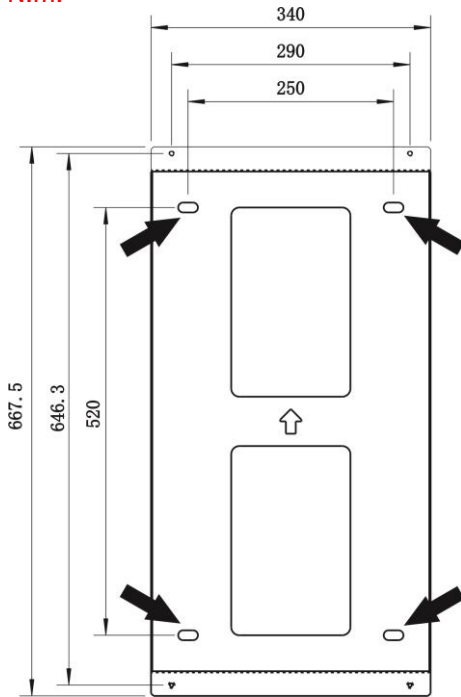

Battery Connection

CAUTION: For safety operation and regulation compliance, it's requested to install a separate DC over-current protector or disconnect the device between battery and inverter. It may not be necessary to disconnect the device for some applications, however, it's requested to have over-current protection installed. Please refer to the typical amperage in the table below as required fuse or size of the breaker.

WARNING! All wiring must be performed by a qualified personnel.

WARNING! It's very important for system safety and efficient operation to use appropriate cable for battery connection. To reduce risk of injury, please use proper cables and suitable size of terminal recommended below.

Ring terminal:

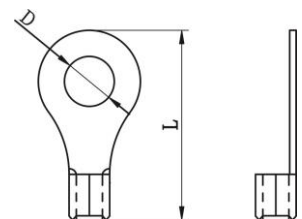

Recommended battery cables and size of terminal:

Model	Typical Amperage	Battery Capacity	Wire Size	Ring Terminal			Torque Value
				Cable mm ²	Dimensions		
					D (mm)	L (mm)	
6KW	220A	200AH	1*1/0AWG	60	8.4	49.7	5~6 Nm
			2*4AWG	44	8.4	49.7	

Please follow the steps below to implement the battery connection:

1. Assemble battery ring terminal based on recommended battery cable and terminal size.
2. Connect all battery packs as units requires. It's suggested to connect at least 200Ah capacity battery for 5KW model.
3. Insert the ring terminal of battery cable flatly into battery connector of inverter and make sure the bolts are tightened with torque of 5-6 Nm. Make sure polarity at both the battery and the inverter is correctly connected and ring terminals are tightly screwed to the battery terminals.

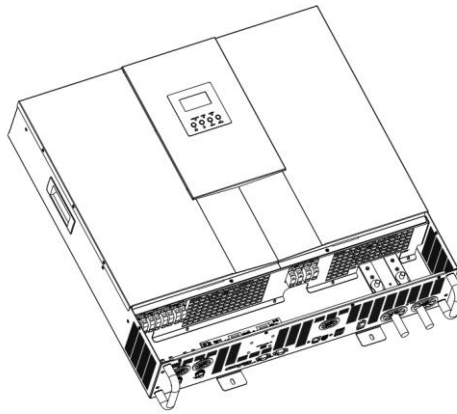

4. Connect all battery packs as below chart.

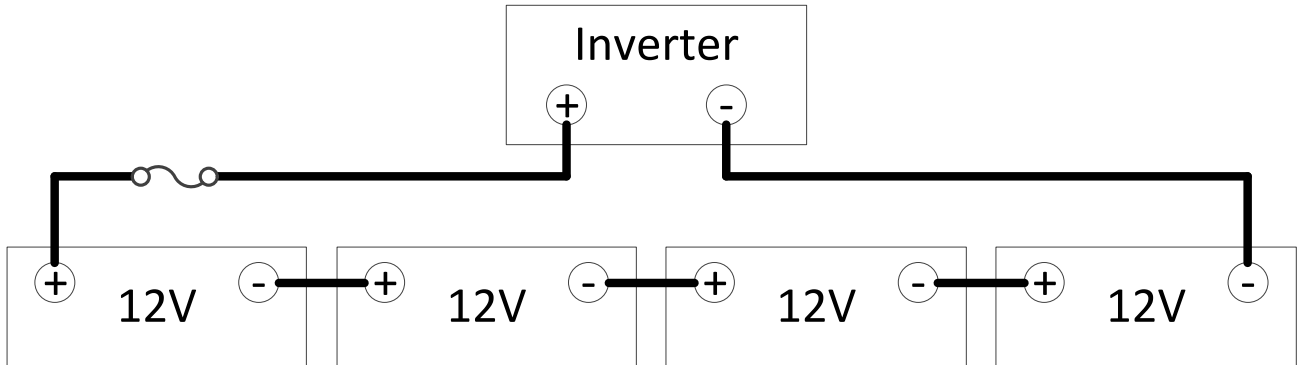

 **WARNING: Shock Hazard**
Installation must be performed with care due to high battery voltage in series.

 **CAUTION!!** Do not place anything between the flat part of the inverter terminal and the ring terminal. Otherwise, overheating may occur.
CAUTION!! Do not apply any anti-oxidant substance on the terminals before the terminals are connected tightly.
CAUTION!! Before making the final DC connection or closing DC breaker/disconnector, be sure positive (+) must be connected to positive (+) and negative (-) must be connected to negative (-).

AC Input/Output Connection

CAUTION!! Before connecting to AC input power source, please install a **separate** AC breaker between inverter and AC input power source. This will ensure the inverter can be securely disconnected during maintenance and fully protected from over current of AC input. The recommended spec of AC breaker is 40A for 6KVA.

CAUTION!! There are two terminal blocks with "IN" and "OUT" markings. Please do NOT mis-connect input and output connectors.

WARNING! All wiring must be performed by the qualified personnel.

WARNING! It's necessary to connect AC input N wire. Otherwise, the inverter will NOT be able to detect AC input.

WARNING! It's very important for system safety and efficient operation to use appropriate cable for AC input connection. To reduce risk of injury, please use the recommended cable size as below.

Suggested cable requirement for AC wires

Model	Gauge	Torque Value
6KVA	10 AWG	1.4~ 1.6Nm

There are three applications for different AC input as shown in the figure below. For phase angle operation, please refer to LCD #28

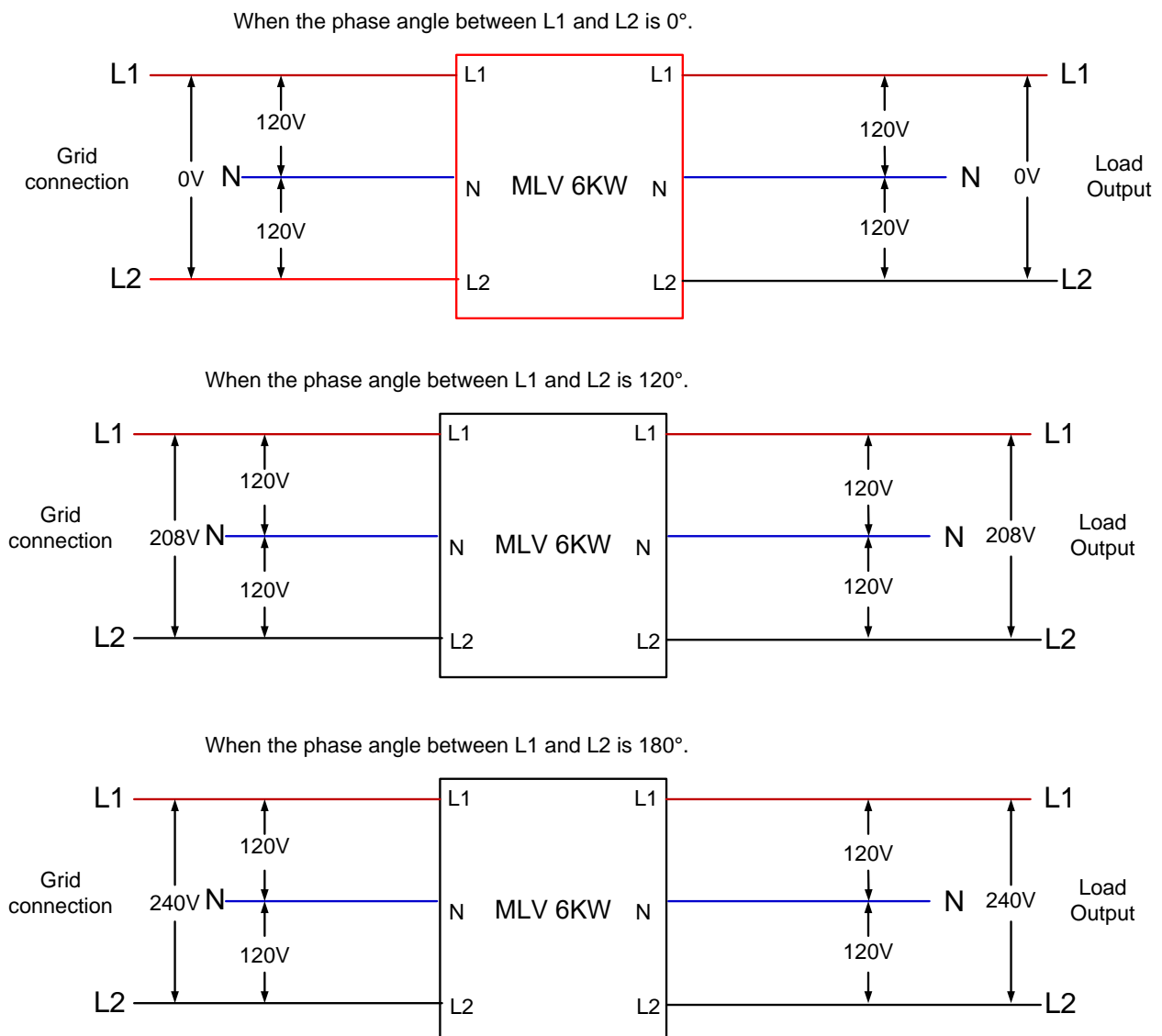

Please follow below steps to implement AC input/output connection:

1. Before making AC input/output connection, be sure to open DC protector or disconnecter first.
2. Remove insulation sleeve 10mm from the six conductors. And short-circuit phase L and neutral conductor N 3 mm.
3. Insert AC input wires according to polarities indicated on terminal block and tighten the terminal screws. Be sure to connect PE protective conductor (⊕) first.

⊕ → **Ground (yellow-green)**

L1 → **LINE (black)**

L2 → **LINE (brown)**

N → **Neutral (blue)**

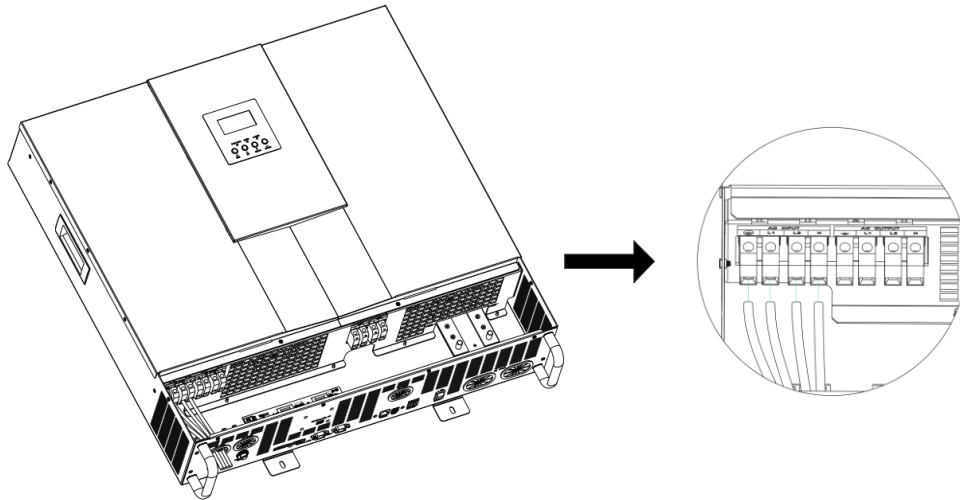

WARNING:

Be sure that AC power source is disconnected before attempting to hardwire it to the unit.

4. Then, insert AC output wires according to polarities indicated on terminal block and fasten the terminal screws. Be sure to connect PE protective conductor (⊕) first.

⊕ → **Ground (yellow-green)**

L1 → **LINE (black)**

L2 → **LINE (brown)**

N → **Neutral (blue)**

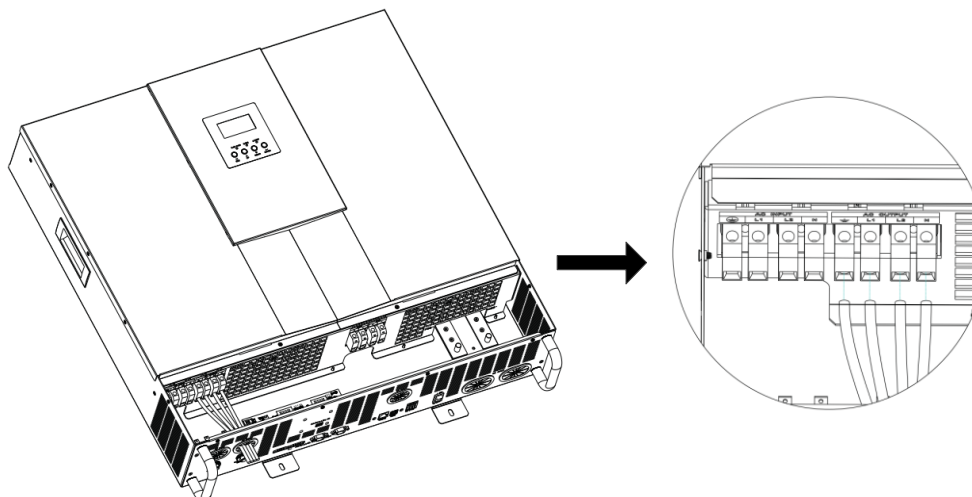

5. Make sure the wires are securely connected.

CAUTION: Important

Be sure to connect AC wires with correct polarity. If L and N wires are connected reversely, it may cause utility short-circuited when these inverters are worked in parallel operation.

CAUTION: Appliances such as air conditioner are required at least 2~3 minutes to restart because it's required to have enough time to balance refrigerant gas inside of circuits. If a power shortage occurs and recovers in a short time, it will cause damage to your connected appliances. To prevent this kind of damage, please check with the manufacturer of the air conditioner if it's equipped with time-delay function before installation. Otherwise, this inverter/charger will cause overload fault and cut off the output to protect your appliance but sometimes it still causes internal damage to the air conditioner.

PV Connection

CAUTION: Before connecting to PV modules, please install **separately** a DC circuit breaker between inverter and PV modules.

WARNING! All wiring must be performed by a qualified personnel.

WARNING! It's very important for system safety and efficient operation to use appropriate cable for PV module connection. To reduce risk of injury, please use the recommended cable size as below.

NOTICE! When only one MPPT is used, please use MPPT1 first.

Model	Typical Amperage	Cable Size	Torque
6KVA	80A	8 AWG	1.4~1.6 Nm

PV Module Selection:

When selecting proper PV modules, please be sure to consider the parameters below:

1. Open circuit Voltage (Voc) of PV modules can't exceed the maximum voltage of the PV array open circuit of the inverter.
2. Open circuit Voltage (Voc) of PV modules should be higher than the minimum voltage of the battery.

Solar Charging Mode	
Solar Charger Type	MPPT
Number of MPPT	2
Max. PV Array Open Circuit Voltage	145Vdc
PV Array MPPT Voltage Range	60~115Vdc
Min. battery voltage for PV charge	34Vdc

Please follow the steps below to implement PV module connection:

1. Remove insulation sleeve 10 mm from positive and negative conductors.
2. Check the correct polarity of connected cable from PV modules and PV input connectors. Then, connect positive pole (+) of connection cable to positive pole (+) of PV input connector. Connect negative pole (-) of connection cable to negative pole (-) of PV input connector.
3. Make sure the wires are securely connected.

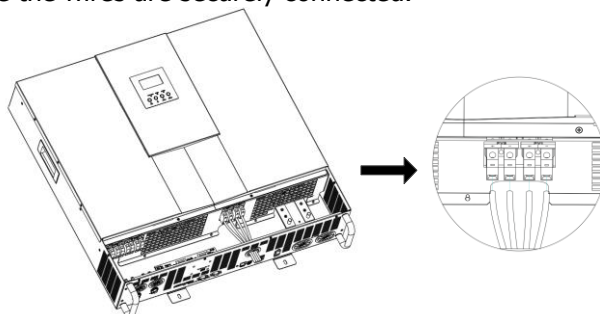
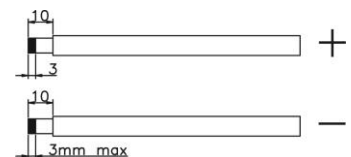

Final Assembly

After connecting all wirings, please put the bottom cover back by fixing two screws as shown below.

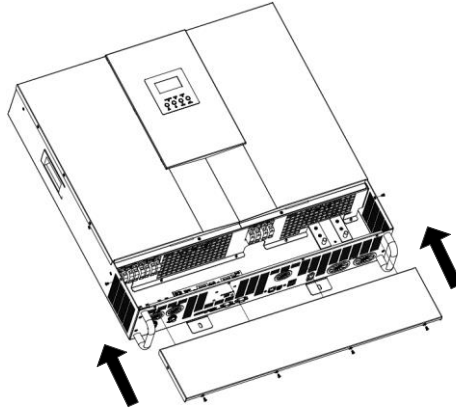

Communication Connection

Please use supplied communication cable to connect to inverter and PC. Insert bundled CD into a computer and follow the on-screen instructions to install the monitoring software. For the detailed software operations, please check user manual of software inside the CD.

Dry Contact Signal

There is one dry contact (3A/120VAC) available on the rear panel. It could be used to deliver signal to external device when battery voltage reaches warning level.

Unit Status	Condition		Dry contact port: 		
			NC & C	NO & C	
Power Off	Unit is off and no output is powered.		Close	Open	
Power On	Output is powered from Utility.		Close	Open	
	Output is powered from Battery or Solar.	Program 01 set as Utility	Battery voltage < Low DC warning voltage	Open	Close
			Battery voltage > Setting value in Program 13 or battery charging reaches floating stage	Close	Open
	Output is powered from Battery or Solar.	Program 01 is set as SBU or Solar first	Battery voltage < Setting value in Program 12	Open	Close
Battery voltage > Setting value in Program 13 or the battery charging reaches the floating stage			Close	Open	

OPERATION

Power ON/OFF

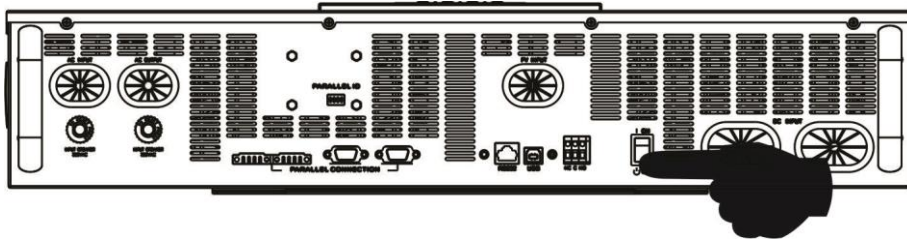

Once the unit has been properly installed and the batteries are connected well, simply press On/Off switch (located on the bottom of the inverter) to turn on the unit.

Operation and Display Panel

The operation and display panel, as shown in the chart below, are on the front panel of the inverter. It includes three indicators, four function keys and an LCD display, indicating the operating status and input/output power information.

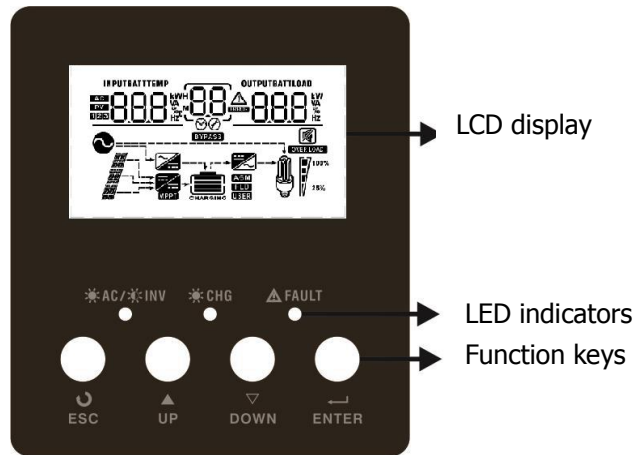

LED Indicator

LED Indicator		Messages	
☀️ AC / ☀️ INV	Green	Solid On	Output is powered by utility in Line mode.
		Flashing	Output is powered by battery or PV in battery mode.
☀️ CHG	Green	Solid On	Battery is fully charged.
		Flashing	Battery is charging.
⚠️ FAULT	Red	Solid On	Fault occurs in the inverter.
		Flashing	Warning occurs in the inverter.

Function Keys

Function Key	Description
ESC	To exit setting mode
UP	To go to previous selection
DOWN	To go to next selection
ENTER	To confirm the selection in setting mode or enter setting mode

LCD Display Icons

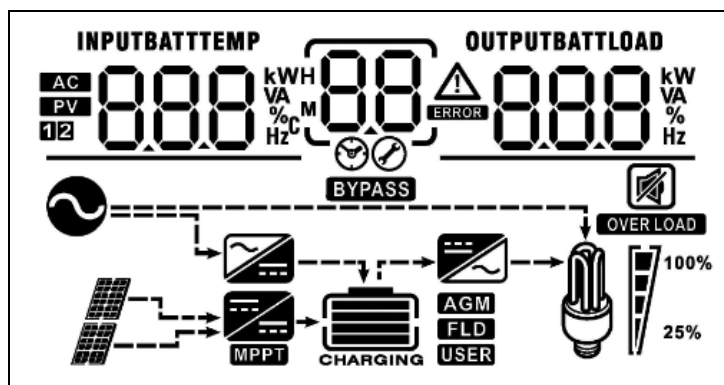

Icon	Function description	
Input Source Information		
AC	Indicates the AC input.	
PV	Indicates the PV input	
1	Indicates the input 1 and output 1 data.	
2	Indicates the input 2 and output 2 data.	
INPUTBATT 888 kW VA % Hz	Indicates input voltage, input frequency, PV voltage, battery voltage and charger current.	
Configuration Program and Fault Information		
88	Indicates the setting programs.	
88 ⚠	Indicates the warning and fault codes. Warning: 88 ⚠ flashing with warning code. Fault: 88 ERROR lighting with fault code	
Output Information		
OUTPUTBATTLOAD 888 kW VA % Hz	Indicate output voltage, output frequency, load percent, load in VA, load in Watt and discharging current.	
Battery Information		
	Indicates battery level by 0-24%, 25-49%, 50-74% and 75-100% in battery mode and charging status in line mode.	
In AC mode, it will present battery charging status.		
Status	Battery voltage	LCD Display
Constant Current mode / Constant Voltage mode	<2V/cell	4 bars will flash in turns.
	2 ~ 2.083V/cell	Bottom bar will be on and the other three bars will flash in turns.
	2.083 ~ 2.167V/cell	Bottom two bars will be on and the other two bars will flash in turns.
	> 2.167 V/cell	Bottom three bars will be on and the top

		bar will flash.		
In floating mode, batteries are fully charged.		4 bars will be on.		
In battery mode, it will present battery capacity.				
Load Percentage	Battery Voltage	LCD Display		
Load > 50%	< 1.717V/cell			
	1.717V/cell ~ 1.8V/cell			
	1.8 ~ 1.883V/cell			
	> 1.883 V/cell			
50% > Load > 20%	< 1.817V/cell			
	1.817V/cell ~ 1.9V/cell			
	1.9 ~ 1.983V/cell			
	> 1.983			
Load < 20%	< 1.867V/cell			
	1.867V/cell ~ 1.95V/cell			
	1.95 ~ 2.033V/cell			
	> 2.033			
Load Information				
	Indicates overload.			
	Indicates the load level by 0-24%, 25-50%, 50-74% and 75-100%.			
	0%~25%	25%~50%	50%~75%	75%~100%
Mode Operation Information				
	Indicates unit connects to the mains.			
	Indicates unit connects to the PV panel.			
	Indicates load is supplied by utility power.			
	Indicates the utility charger circuit is working.			
	Indicates the DC/AC inverter circuit is working.			
	Indicates the PV charger circuit is working.			
Mute Operation				
	Indicates the alarm is disabled.			

LCD Setting

















After pressing and holding the ENTER button for 3 seconds, the unit will enter setting mode. Press "UP" or "DOWN" button to select setting programs. And then, press "ENTER" button to confirm the selection or ESC button to exit.

Setting Programs:





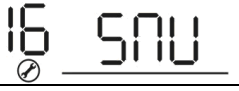
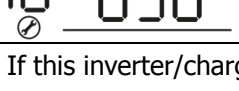

Program	Description	Selectable option	
00	Exit setting mode	Escape 00 ESC	
01	Output source priority: To configure load power source priority	Solar first 01 SOL	Solar energy provides power to the loads as first priority. If solar energy is not sufficient to power all connected loads, battery energy will supply power to the loads at the same time. Utility provides power to the loads only when any one condition stated below happens: - Solar energy is not available - Battery voltage drops to either low DC warning voltage or the setting point in program 12.
		Utility first (default) 01 UTI	Utility will provide power to the loads as first priority. Solar and battery energy will provide power to the loads only when utility power is not available.
		SBU priority 01 SBU	Solar energy provides power to the loads as first priority. If solar energy is not sufficient to power all connected loads, battery energy will supply power to the loads at the same time. Utility provides power to the loads only when battery voltage drops to either low DC warning voltage or the setting point in program 12.
02	Maximum charging current: To configure the total charging current for solar and utility chargers. (Max. charging current = utility charging current + solar charging current)	20A 02 20 ^A	30A 02 30 ^A

02	Maximum charging current: To configure the total charging current for solar and utility chargers. (Max. charging current = utility charging current + solar charging current)	40A 02 40 ^A	50A 02 50 ^A		
		60A (default) 02 60 ^A	70A 02 70 ^A		
		80A 02 80 ^A	90A 02 90 ^A		
		100A 02 100 ^A	110A 02 110 ^A		
		120A 02 120 ^A	130A 02 130 ^A		
		140A 02 140 ^A	150A 02 150 ^A		
		160A 02 160 ^A	170A 02 170 ^A		
		180A 02 180 ^A	190A 02 190 ^A		
		200A 02 200 ^A	210A 02 210 ^A		
		220A 02 220 ^A			
		03	AC input voltage range	Appliances (default) 03 APL	If selected, acceptable AC input voltage range will be within 90-280VAC.
				UPS 03 UPS	If selected, acceptable AC input voltage range will be within 170-280VAC.
05	Battery type	AGM (default) 05 AGM	Flooded 05 FLD		

		User-Defined 05 USE	If "User-Defined" is selected, battery charge voltage and low DC cut-off voltage can be set up in program 26, 27 and 29.
06	Automatically restart when overload occurs	Restart disable (default) 06 LFD	Restart enable 06 LFE
07	Automatically restart when over temperature occurs	Restart disable (default) 07 LFD	Restart enable 07 LFE
08	Output voltage	110V 08 110 ^v	120V (default) 08 120 ^v
09	Output frequency	50Hz 09 50 ^{Hz}	60Hz (default) 09 60 ^{Hz}
11	Maximum utility charging current	10A 11 10A	20A 11 20A
		30A (default) 11 30A	40A 11 40A
		50A 11 50A	60A 11 60A
12	Setting voltage point back to utility source when selecting "SBU priority" or "Solar first" in program 01.	44.0V 12 440 ^v	45.0V (default) 12 450 ^v
		46.0V 12 460 ^v	47.0V 12 470 ^v
		48.0V 12 480 ^v	49.0V 12 490 ^v
		50.0V 12 500 ^v	51.0V 12 510 ^v

13	Setting voltage point back to battery mode when selecting "SBU priority" or "Solar first" in program 01.	Battery fully charged	48.0V
			
		49.0V	50.0V
			
		51.0V	52.0V
			
		53.0V	54.0V
			
55.0V	56.0V		
			
57.0V	58.0V		
			
16	Charger source priority: To configure the priority of charger source	If this inverter/charger is working in Line, Standby or Fault mode, charger source can be programmed as below:	
		Solar first 	Solar energy will charge battery as first priority. Utility will charge battery only when solar energy is not available.
		Utility first 	Utility will charge battery as first priority. Solar energy will charge battery only when utility power is not available.
		Solar and Utility 	Solar energy and utility will charge battery at the same time.
		Only Solar 	Solar energy will be the only charger source no matter utility is available or not.
		If this inverter/charger is working in Battery mode, only solar energy can charge battery. Solar energy will charge battery if it's available and sufficient.	
18	Alarm control	Alarm on (default) 	Alarm off 

19	Automatically return to default display screen	Return to default display screen (default) 19 ESP	If selected, no matter how users switch display screen, it will automatically return to default display screen (Input voltage /output voltage) after no button is pressed for 1 minute.
		Stay at latest screen 19 LEP	If selected, the display screen will stay at the latest screen user finally switches.
20	Backlight control	Backlight on (default) 20 LON	Backlight off 20 LOF
22	Beeps while primary source is interrupted	Alarm on (default) 22 AON	Alarm off 22 AOF
23	Overload bypass: When enabled, the unit will transfer to line mode if overload occurs in battery mode.	Bypass disable (default) 23 byd	Bypass enable 23 byE
25	Record Fault code	Record enable 25 FEN	Record disable (default) 25 FdS
26	Bulk charging voltage (C.V voltage)	Default setting: 56.4V CU 26 ^{BATT} 56.4 _v	
		If self-defined is selected in program 5, this program can be set up. Setting range is from 48.0V to 58.4V. Increment of each click is 0.1V.	
27	Floating charging voltage	Default setting: 54.0V FLV 27 ^{BATT} 54.0 _v	
		If self-defined is selected in program 5, this program can be set up. Setting range is from 48.0V to 58.4V. Increment of each click is 0.1V.	
28	AC output mode *This setting is able to set up only when the inverter is in standby mode. Be sure that on/off switch is in "OFF" status.	Parallel output in single phase. Output voltage is 120V. 28 ^{OUTPUT} 2A0	Support L1 phase output on 3-Phase application. Output voltage is 120V. 28 ^{OUTPUT} 3P 1

28	AC output mode *This setting is able to set up only when the inverter is in standby mode. Be sure that on/off switch is in "OFF" status.	Support L2 phase output on 3-Phase application. Output voltage is 120V.	Support L3 phase output on 3-Phase application. Output voltage is 120V.
			
		Support L1/L2 phase output on split phase application with L1 to L2 output voltage in 208V.	Support L1/L2 phase output on split phase application with L1 to L2 output voltage in 240V.
			
29	Low DC cut-off voltage	Default setting: 42.0V	
			
30	PV judge condition (Only apply for setting "Solar first" in program 1: Output source priority)	One Inverter (Default): 	When "ONE" is selected, as long as one of the inverters has been connected to PV modules and PV input is normal, parallel or 3-phase system will continue working according to rule of "solar first" setting. For example, two units are connected in parallel and set "SOL" in output source priority. If one of the two units has connected to PV modules and PV input is normal, the parallel system will provide power to loads from solar or battery power. If both of them are not sufficient, the system will provide power to loads from utility.
		All of Inverters: 	When "ALL" is selected, parallel or 3-phase system will continue working according to rule of "solar first" setting only when all of inverters are connected to PV modules. For example, two units are connected in parallel and set "SOL" in output source priority. When "ALL" is selected in program 30, it's necessary to have all inverters connected to PV modules and PV input is normal to allow the system to provide power to loads from solar and battery power. Otherwise, the system will provide power to loads from utility.

31	Solar power balance: When enabled, solar input power will be automatically adjusted according to the connected load power.	Solar power balance enable (Default): 31 <u>5bE</u>	If selected, solar input power will be automatically adjusted according to the following formula: Max. input solar power = Max. battery charging power + Connected load power.
		Solar power balance disable: 31 <u>5bd</u>	If selected, the solar input power will be the same as max. battery charging power no matter how many loads are connected. The max. battery charging power will be based on the setting current in program 02. (Max. solar power = Max. battery charging power)
32	Bulk charging time (C.V stage)	Automatically (Default): 32 <u>AUT</u>	If selected, inverter will judge this charging time automatically.
		5 min 32 <u>5</u>	The setting range is from 5 min to 900 min. Increment of each click is 5 min.
		900 min 32 <u>900</u>	
If "USE" is selected in program 05, this program can be set up.			
33	Battery equalization	Battery equalization 33 <u>EEN</u>	Battery equalization disable (default) 33 <u>EdS</u>
		If "Flooded" or "User-Defined" is selected in program 05, this program can be set up.	
34	Battery equalization voltage	Default setting: 58.4V. Setting range is from 48V ~ 58.4V. Increment of each click is 0.1V. <u>EV</u> 34 <u>58.4</u> ^{BATT} v	
35	Battery equalized time	60min (default) 35 <u>60</u>	Setting range is from 5min to 900min. Increment of each click is 5min.
36	Battery equalized timeout	120min (default) 36 <u>120</u>	Setting range is from 5min to 900 min. Increment of each click is 5 min.
37	Equalization interval	30days (default) 37 <u>30d</u>	Setting range is from 0 to 90 days. Increment of each click is 1 day
39	Equalization activated immediately	Enable 39 <u>AEN</u>	Disable (default) 39 <u>AdS</u>

		<p>If equalization function is enabled in program 33, this program can be set up. If "Enable" is selected in this program, it's to activate battery equalization immediately and LCD main page will shows "E9". If "Disable" is selected, it will cancel equalization function until next activated equalization time arrives based on program 37 setting. At this time, "E9" will not be shown in LCD main page.</p>
--	--	---

Display Setting





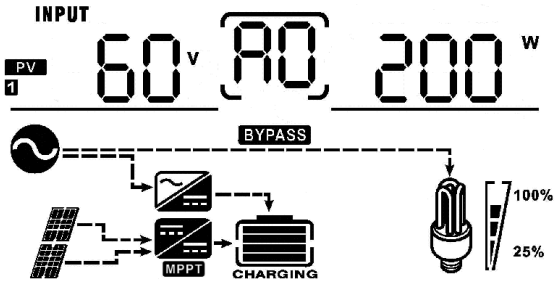
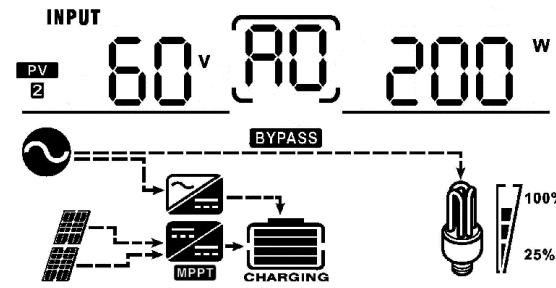
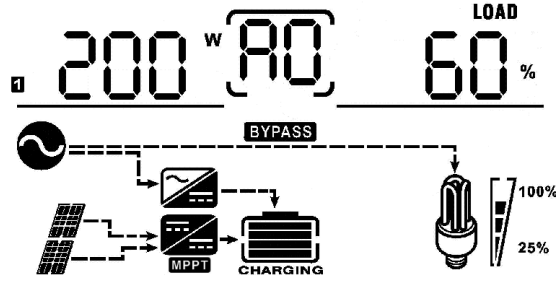
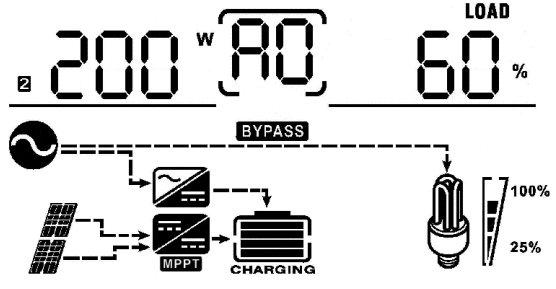
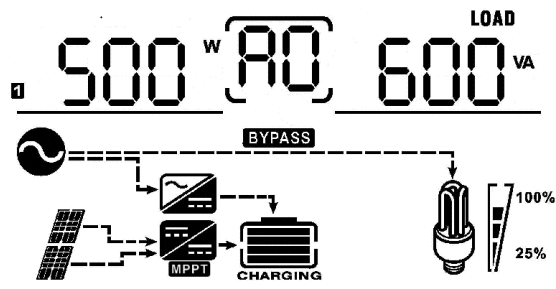

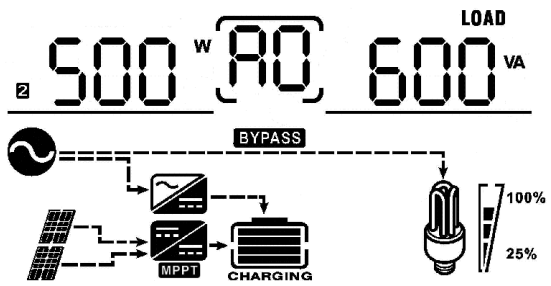
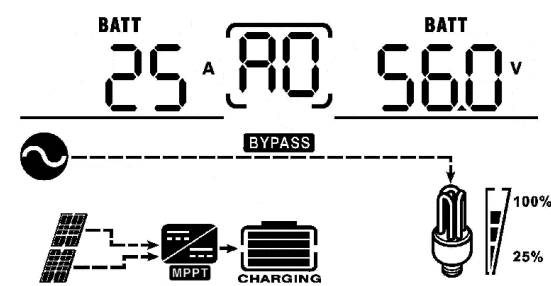
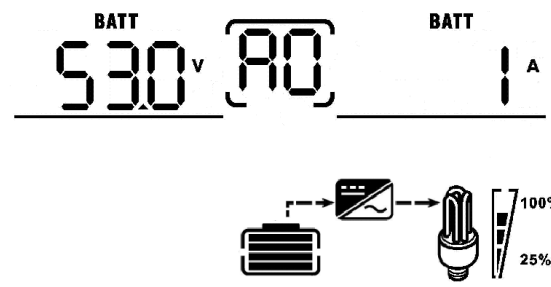
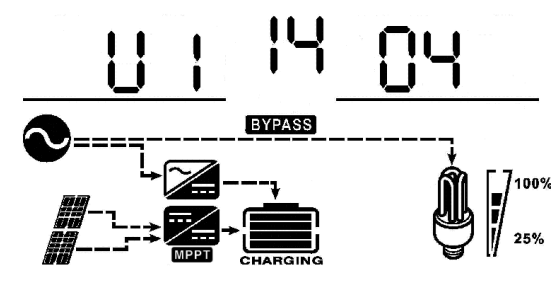
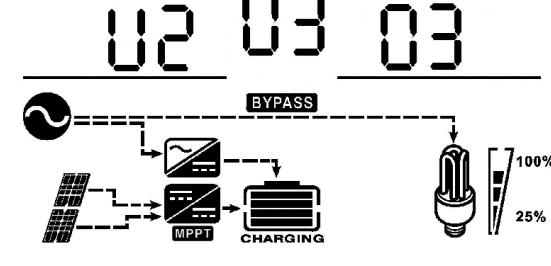
The LCD display information will be switched in turns by pressing "UP" or "DOWN" key. The selectable information is switched as the following table order.

Selectable information	LCD display
AC Input 1 voltage/ AC output 1 voltage (Default Display Screen)	<p>AC Input 1 Voltage=230V, AC output 1 voltage=230V</p>
AC Input 2 voltage/ AC output 2 voltage	<p>AC Input 2 Voltage=230V, AC output 2 voltage=230V</p>
AC Input 1 frequency/ AC output 1 frequency	<p>AC Input 1 frequency=50Hz, AC output 1 frequency=50Hz</p>
AC Input 2 frequency / AC output 2 frequency	<p>AC Input 2 frequency=50Hz, AC output 2 frequency=50Hz</p>

<p>MPPT Input 1 Charging current / MPPT Input 1 Charging power</p>	<p>PV1 voltage=60V , PV1 Power = 200W</p>  <p>The display shows 'INPUT' with 'PV 1' on the left, '60 V' in the middle, 'A0' in a box in the middle, and '200 W' on the right. Below the display is a diagram showing a solar panel connected to an MPPT controller, which is connected to a battery labeled 'CHARGING'. A 'BYPASS' switch is shown between the solar panel and the MPPT controller. To the right, a light bulb is shown with a meter indicating 100% and 25%.</p>
<p>MPPT Input 2 Charging current / MPPT Input 2 Charging power</p>	<p>PV2 voltage=60V ,PV2 Power = 200W</p>  <p>The display shows 'INPUT' with 'PV 2' on the left, '60 V' in the middle, 'A0' in a box in the middle, and '200 W' on the right. Below the display is a diagram showing a solar panel connected to an MPPT controller, which is connected to a battery labeled 'CHARGING'. A 'BYPASS' switch is shown between the solar panel and the MPPT controller. To the right, a light bulb is shown with a meter indicating 100% and 25%.</p>
<p>Load 1 Watt/ Load 1 percentage</p>	<p>Load 1 Watt=200W, Load 1 percent=60%</p>  <p>The display shows 'LOAD' with '1' on the left, '200 W' in the middle, 'A0' in a box in the middle, and '60 %' on the right. Below the display is a diagram showing a solar panel connected to an MPPT controller, which is connected to a battery labeled 'CHARGING'. A 'BYPASS' switch is shown between the solar panel and the MPPT controller. To the right, a light bulb is shown with a meter indicating 100% and 25%.</p>
<p>Load 2 Watt/ Load 2 percentage</p>	<p>Load 2 Watt=200W, Load 2 percent=60%</p>  <p>The display shows 'LOAD' with '2' on the left, '200 W' in the middle, 'A0' in a box in the middle, and '60 %' on the right. Below the display is a diagram showing a solar panel connected to an MPPT controller, which is connected to a battery labeled 'CHARGING'. A 'BYPASS' switch is shown between the solar panel and the MPPT controller. To the right, a light bulb is shown with a meter indicating 100% and 25%.</p>
<p>Load 1 Watt/ Load 1 in VA</p>	<p>Load 1 Watt=200W, Load 1 in VA=600VA</p>  <p>The display shows 'LOAD' with '1' on the left, '500 W' in the middle, 'A0' in a box in the middle, and '600 VA' on the right. Below the display is a diagram showing a solar panel connected to an MPPT controller, which is connected to a battery labeled 'CHARGING'. A 'BYPASS' switch is shown between the solar panel and the MPPT controller. To the right, a light bulb is shown with a meter indicating 100% and 25%.</p>

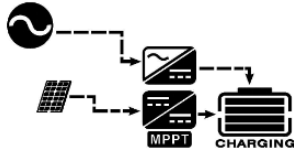
<p>Load 2 Watt/ Load 2 in VA</p>	<p>Load 2 Watt 200W, Load 2 in VA=600VA</p> 
<p>DC charging current / Battery voltage</p>	<p>Charging current=25A, Battery voltage=56.0V</p> 
<p>Battery voltage/ DC discharging current</p>	<p>Battery voltage=53.0V, discharging current=1A</p> 
<p>Main CPU version checking</p>	<p>Main CPU version 00014.04</p> 
<p>Secondary CPU version checking</p>	<p>Secondary CPU version: 00003.03</p> 











Operating Mode Description

Operation mode	Description	LCD display
<p>Standby mode</p> <p>Note:</p> <p>*Standby mode: The inverter is not turned on yet but at this time, the inverter can charge battery without AC output.</p>	<p>No output is supplied by the unit but it still can charge the batteries.</p>	<p>Charging by utility.</p> 
		<p>Charging by PV energy.</p> 
		<p>Charging by PV energy and utility</p> 
		<p>No charging.</p> 
<p>Fault mode</p> <p>Note:</p> <p>*Fault mode: Errors are caused by internal circuit errors or external reasons such as over temperature, output short circuited and so on.</p>	<p>PV energy can charge the batteries.</p>	<p>Charging by PV energy.</p> 
		<p>No charging.</p> 









Line Mode	The unit will provide output power from the mains. It will also charge the battery in line mode.	<p>Charging by PV energy</p>
		<p>Charging by utility.</p>
		<p>Charging by PV energy and utility</p>
Battery Mode	The unit will provide output power from battery and PV power.	<p>Power from battery and PV energy.</p>
		<p>Power from battery only.</p>

Fault Reference Code

Fault Code	Fault Event	Icon on
01	Fan is locked when inverter is off.	
02	Over temperature	
03	Battery voltage is too high	
04	Battery voltage is too low	
05	Output short circuited or over temperature is detected by internal converter components.	
06	Output voltage is too high.	
07	Overload time out	
08	Bus voltage is too high	
09	Bus soft start failed	
11	Main relay failed	

51	Over current or surge	
52	Bus voltage is too low	
53	Inverter soft start failed	
55	Over DC voltage in AC output	
56	Battery connection is open	
57	Current sensor failed	
58	Output voltage is too low	
87	Internal circuit mismatch	
88	Parallel ID missing	
89	Parallel ID in conflict	
91	Working mode synchronization loss	

Warning Indicator

Warning Code	Warning Event	Audible Alarm	Icon flashing
01	Fan is locked when inverter is on.	Beep three times every second	
03	Battery is over-charged	Beep once every second	
04	Low battery	Beep once every second	
07	Overload	Beep once every 0.5 second	
10	Output power derating	Beep twice every 3 seconds	
12	Solar charger stops due to low battery.		
13	Solar charger stops due to high PV voltage.		
14	Solar charger stops due to overload.		
SL	Wrong wiring in LCD panel		

SPECIFICATIONS

Table 1: Line Mode Specifications

INVERTER MODEL	6KVA
Input Voltage Waveform	Sinusoidal (utility or generator)
Nominal Input Voltage	110/120Vac(L-N or L1-N-L2)
Low Loss Voltage	95Vac±7V (UPS) 65Vac±7V (Appliances)
Low Loss Return Voltage	100Vac±7V (UPS); 70Vac±7V (Appliances)
High Loss Voltage	140Vac±7V
High Loss Return Voltage	135Vac±7V
Max AC Input Voltage	150Vac
Nominal Input Frequency	50Hz / 60Hz (Auto-detection)
Low Loss Frequency	40±1Hz
Low Loss Return Frequency	42±1Hz
High Loss Frequency	65±1Hz
High Loss Return Frequency	63±1Hz
Output Short Circuit Protection	Line mode: Circuit Breaker Battery mode: Electronic Circuits
Max bypass current	40A
Efficiency (Line Mode)	>95% (Rated R load, battery full charged)
Transfer Time (P1-N-P2)	10ms typical, 12ms maximum @50Hz (UPS); 20ms typical, 25ms maximum @50Hz (Appliances)
Transfer Time (P-N)	30ms @50Hz
<p>Output power derating: When AC input voltage drops to 95V, the output power will be derated.</p>	<p>120Vac model:</p> 

Table 2: Inverter Mode Specifications

INVERTER MODEL	6KVA
Rated Output Power	6KVA/6KW
Output Voltage Waveform	Pure Sine Wave
Output Voltage Regulation	110/120Vac(L-N or L1-N-L2)
Output Frequency	60Hz or 50Hz
Peak Efficiency	90%
Overload Protection	5s@≥150% load; 10s@110%~150% load
Surge Capacity	2* rated power for 5 seconds
Nominal DC Input Voltage	48Vdc
Cold Start Voltage	46.0Vdc
Low DC Warning Voltage @ load < 20% @ 20% ≤ load < 50% @ load ≥ 50%	44.0Vdc 42.8Vdc 40.4Vdc
Low DC Warning Return Voltage @ load < 20% @ 20% ≤ load < 50% @ load ≥ 50%	46.0Vdc 44.8Vdc 42.4Vdc
Low DC Cut-off Voltage @ load < 20% @ 20% ≤ load < 50% @ load ≥ 50%	42.0Vdc 40.8Vdc 38.4Vdc
High DC Recovery Voltage	58Vdc
High DC Cut-off Voltage	60Vdc
No Load Power Consumption	<100W

Table 3: Charging Mode Specifications

Utility Charging Mode	
INVERTER MODEL	6KVA
Charging Current (UPS) @ Nominal Input Voltage	2A/10A/20A/30A/40A/50A/60A
Bulk Charging Voltage	
Flooded Battery	58.4Vdc
AGM / Gel Battery	56.4Vdc
Floating Charging Voltage	54Vdc
Overcharge Protection	60Vdc
Charging Algorithm	3-Step

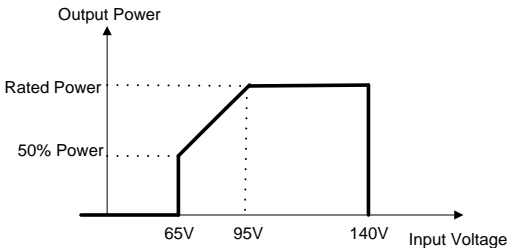
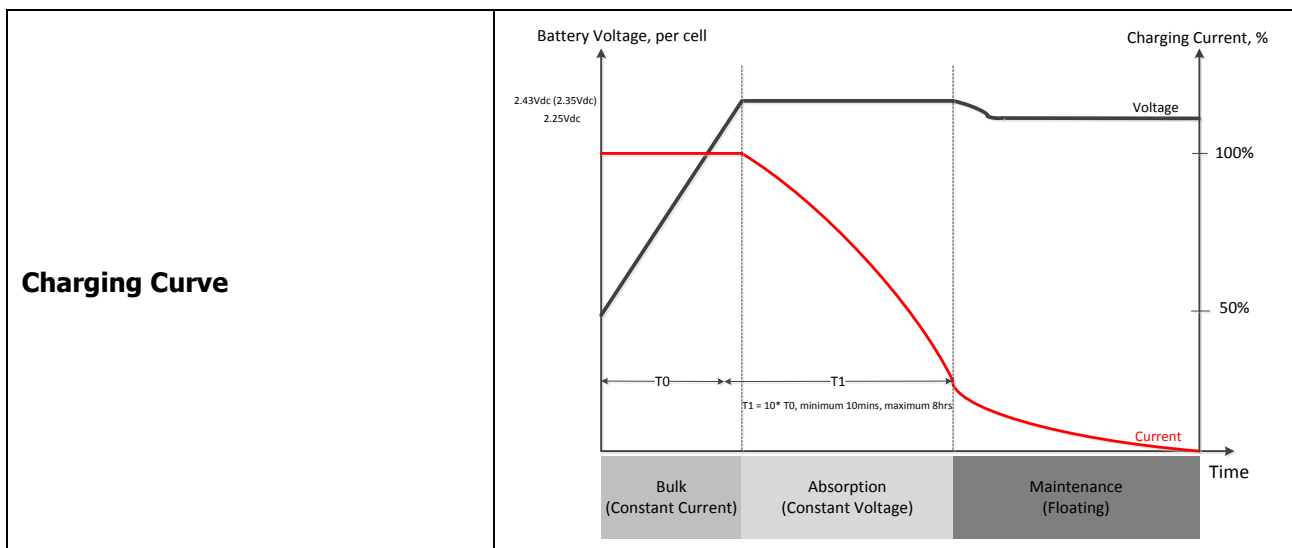

Solar Charging Mode(Per number of MPPT)	
INVERTER MODEL	6KVA
Rated Power	4000 W x 2
Max. efficiency	96%
Max. PV Array Open Voltage	145Vdc
PV Array MPPT Voltage Range	60~115Vdc
Min. battery voltage for PV charge	34Vdc
Standby Power Consumption	<23W
Battery Voltage Accuracy	+/-0.3%
PV Voltage Accuracy	+/-2V
Charging Algorithm	3-Step
Joint Utility and Solar Charging	
INVERTER MODEL	6KVA
Max. Charging Current	220A
Default Charging Current	60Amp

Table 4 General Specifications

INVERTER MODEL	6KVA
Safety Certification	CE
Operating Temperature Range	-10°C to 50°C
Storage temperature	-15°C~ 60°C
Dimension (D*W*H), mm	130 x 622.6 x 610
Net Weight, kg	30

TROUBLESHOOTING

Problem	LCD/LED/Buzzer	Explanation / Possible cause	What to do
Unit shuts down automatically during startup process.	LCD/LEDs and buzzer will be active for 3 seconds and then completely off.	The battery voltage is too low (<1.91V/Cell)	1. Re-charge the battery. 2. Replace the battery.
No response after power on.	No indication.	1. The battery voltage is far too low. (<1.4V/Cell) 2. Battery polarity is connected reversely.	1. Check if batteries and the wiring are connected well. 2. Re-charge the battery. 3. Replace the battery.
Mains exist but the unit works in battery mode.	Input voltage is displayed as 0 on the LCD and green LED is flashing.	Input protector is tripped	Check if AC breaker is tripped and AC wiring is connected well.
	Green LED is flashing.	Insufficient quality of AC power. (Shore or Generator)	1. Check if AC wires are too thin and/or too long. 2. Check if generator (if applied) is working well or if the setting range of input voltage is correct. (UPS→Appliance)
	Green LED is flashing.	Set "Solar First" as the priority of output source.	Change output source priority to Utility first.
When the unit is turned on, internal relay is switched on and off repeatedly.	LCD display and LEDs are flashing	Battery is disconnected.	Check if battery wires are connected well.
Buzzer beeps continuously and red LED is on.	Fault code 07	Overload error. The inverter is overload by 110% and time is up.	Reduce the connected load by switching off some equipment.
	Fault code 05	Output short circuited.	Check if wiring is connected well and remove abnormal load.
		The temperature of internal converter is over 120°C. (Only available for 1-6KVA models.)	Check whether the air flow of the unit is blocked or whether the ambient temperature is too high.
	Fault code 02	The internal temperature of the inverter is over 100°C.	
	Fault code 03	Battery is over-charged.	Return to repair center.
		The battery voltage is too high.	Check if spec and quantity of the batteries meet the requirements.
	Fault code 01	Fan fault	Replace the fan.
	Fault code 06/58	Output abnormal (Inverter voltage is lower than 190Vac or is higher than 260Vac)	1. Reduce the connected load. 2. Return it to repair center
	Fault code 08/09/53/57	Internal components failed.	Return it to repair center.
	Fault code 51	Over current or surge.	Restart the unit, if the error happens again, please return it to repair center.
	Fault code 52	Bus voltage is too low.	
Fault code 55	Output voltage is unbalanced.		
Fault code 56	Battery is not connected well or fuse is burnt.	If the battery is connected well, please return it to repair center.	

Appendix I: Approximate Back-up Time Table

Model	Load (VA)	Backup Time @48Vdc 200Ah (min)	Backup Time @48Vdc 400Ah (min)
6KVA	500	1226	2576
	1000	536	1226
	1500	316	804
	2000	222	542
	2500	180	430
	3000	152	364
	3500	130	282
	4000	100	224
	4500	88	200
	5000	80	180

Note: Backup time depends on the quality of the battery, age of battery and type of battery. Specifications of batteries may vary depending on different manufacturers.

Appendix II: Parallel function

1. Introduction

This inverter can be used in parallel with **three** different operation modes.

1. Parallel operation in single phase with up to **three** units. The supported maximum output power is 18KW/18KVA.
2. Maximum **three** units work together to support three-phase equipment. The supported maximum output power is 18KW/18KVA.
3. Maximum **three** units work together to support two-phase equipment. One units support two phase. The supported maximum output power is 18KW/18KVA and one phase can be up to 7.5KW/7.5KVA.

2. Package Contents

In parallel kit, you will find the following items in the package:



Parallel communication cable



Current sharing cable

3. Mounting the Unit

When installing multiple units, please follow the illustration below.

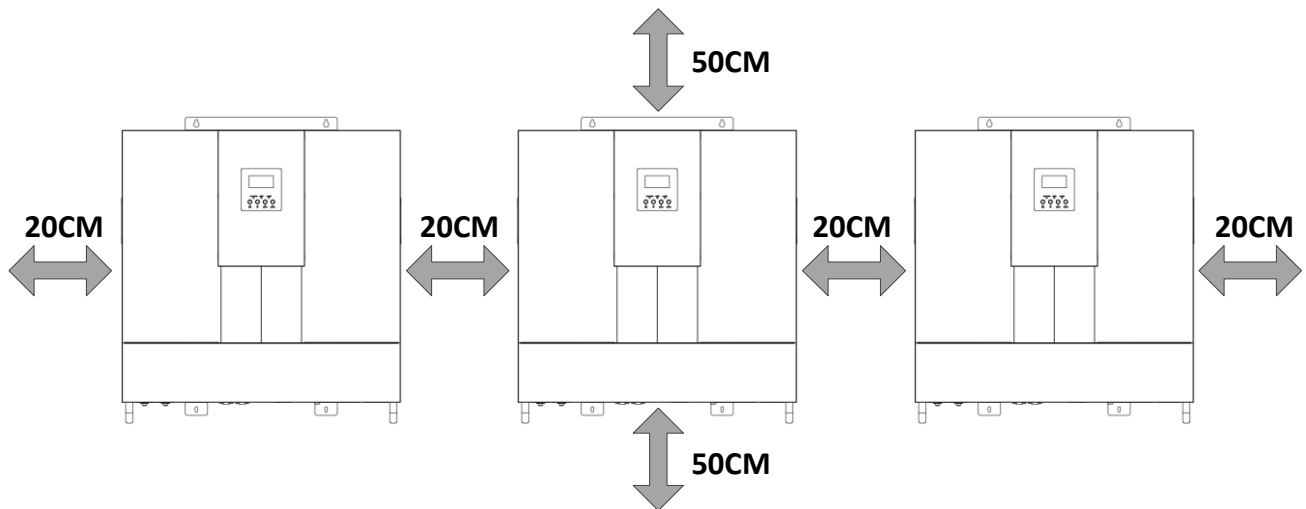

NOTE: For proper air circulation to dissipate heat, allow a clearance of approx. 20 cm to the side and approx. 50 cm above and below the unit. Be sure to install each unit in the same height.

4. Wiring Connection

The size of the cable for each inverter is shown as below:

WARNING: Be sure the length of all battery cables is the same. Otherwise, there will be voltage difference between inverter and battery which might cause mal-function of the parallel inverters.

Recommended battery cable and terminal size for each inverter:

Model	Wire Size	Torque value
6KVA	2*4AWG	5~ 6 Nm

Recommended cable size of AC input and output for each inverter:

Model	AWG no.	Torque
6KVA	10 AWG	1.4~1.6Nm

You need to connect the cables of each inverter together. Take the battery cables for example: You need to use a connector or bus-bar as a joint to connect the battery cables together, and then connect it to the battery terminal. The size of the cable used from joint to battery should be X times cable size in the tables above. "X" indicates the number of inverters connected in parallel.

Regarding AC input and output, please also follow the same principle.

WARNING! Please make sure all output N wires of each inverter must be connected always. Otherwise, it will cause inverter fault in error code # 72.

CAUTION!! Please install the breaker at the battery and AC input side. This will ensure the inverter can be securely disconnected during maintenance and fully protected from over current of battery or AC input. The recommended mounted location of the breakers is shown in the parallel diagrams in section 5-1 and 5-2.

Recommended specification of battery breaker for each inverter:

Model	1 unit*
6KVA	125A/80VDC

*If you want to use only one breaker at the battery side for the whole system, the rating of the breaker should be X times current of 1 unit. "X" indicates the number of inverters connected in parallel.

Recommended specification of AC input breaker in single phase:

Model	2 units	3 units
6KVA	80A/230VAC	120A/230VAC

Note 1: You also can use only one 40A breaker for each inverter at its AC input.

Note 2: Regarding three-phase system, you can use 3-pole breaker directly and the rating of the breaker should be compatible with the phase current limitation from the phase with maximum units.

Recommended battery capacity

Inverter parallel numbers	2	3
Battery Capacity	400AH	600AH

WARNING! Be sure that all inverters will share the same battery bank. Otherwise, the inverters will be transferred to fault mode.

4-1. Parallel Operation in Single phase

Two inverters in parallel:

Power Connection

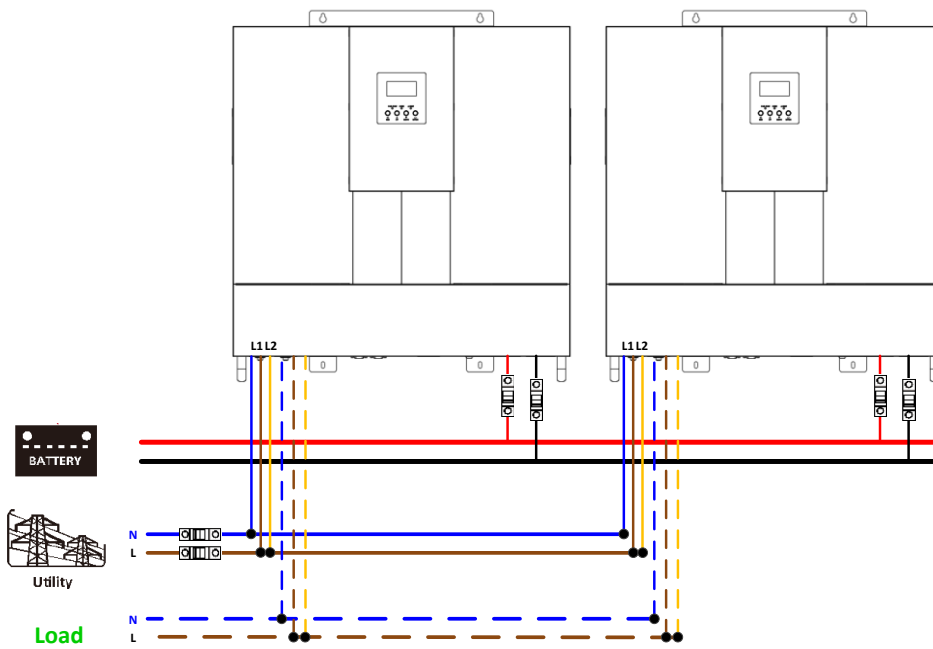

Communication Connection

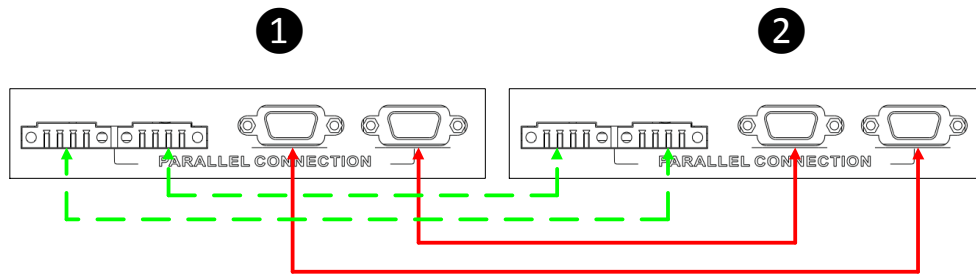

Three inverters in parallel:

Power Connection

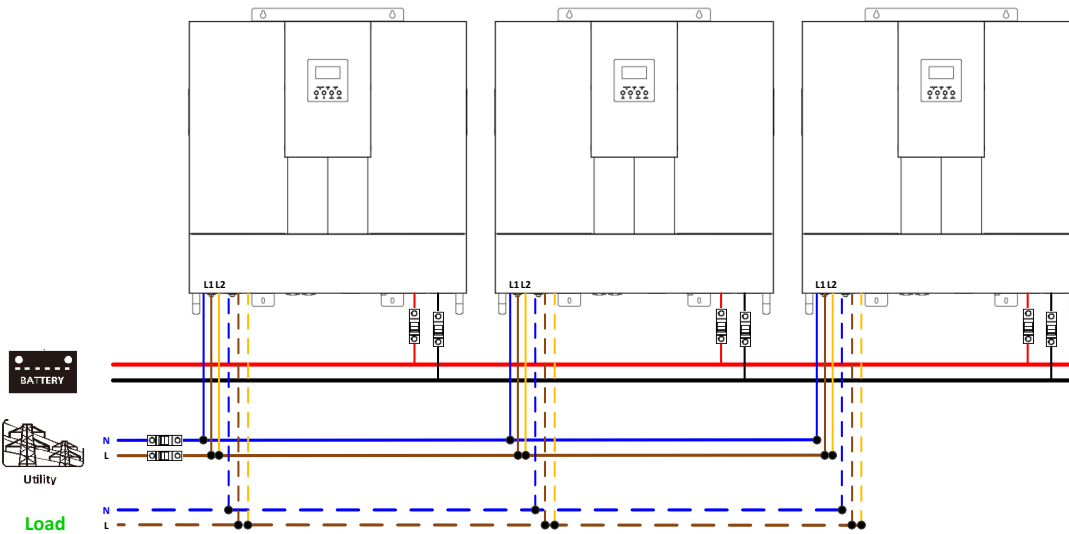

Communication Connection

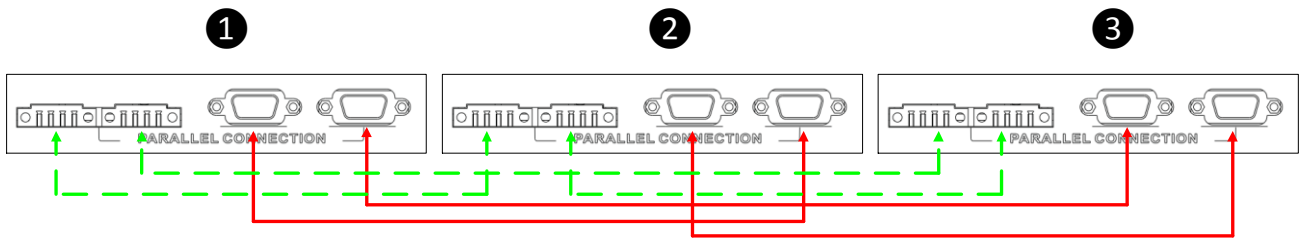

4-2. Support 2-phase equipment

Two inverters in parallel (Line to Line output voltage is 208V):

Power Connection

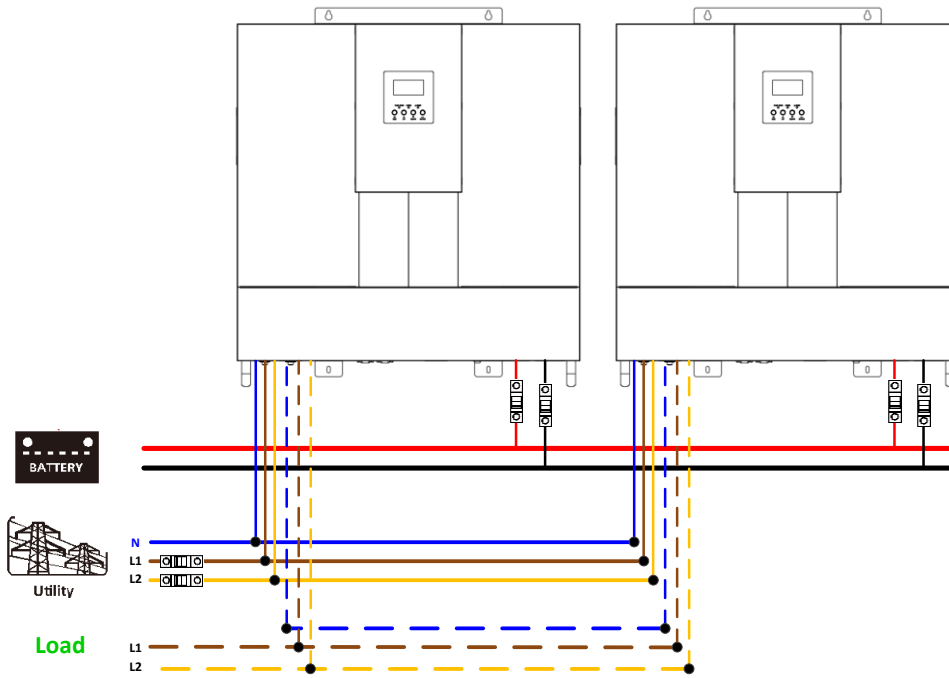

Communication Connection

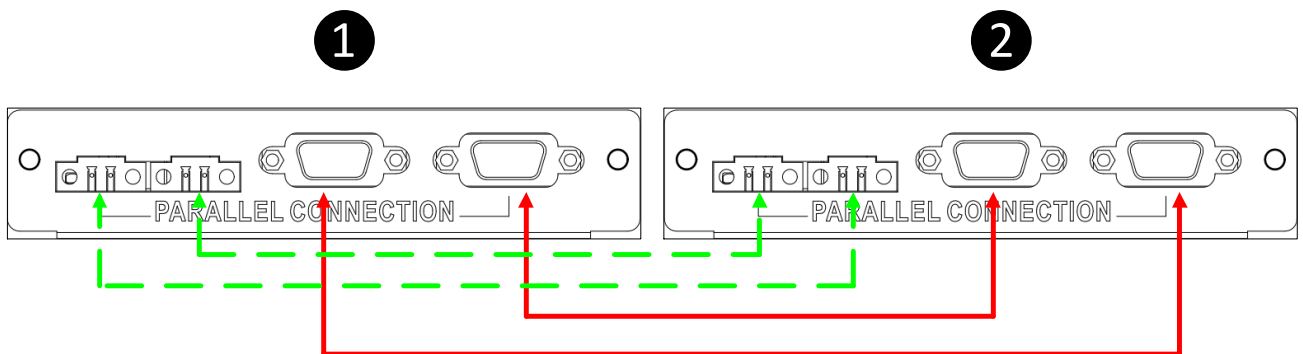

Two inverters in parallel (Line to Line output voltage is 240V):

Power Connection

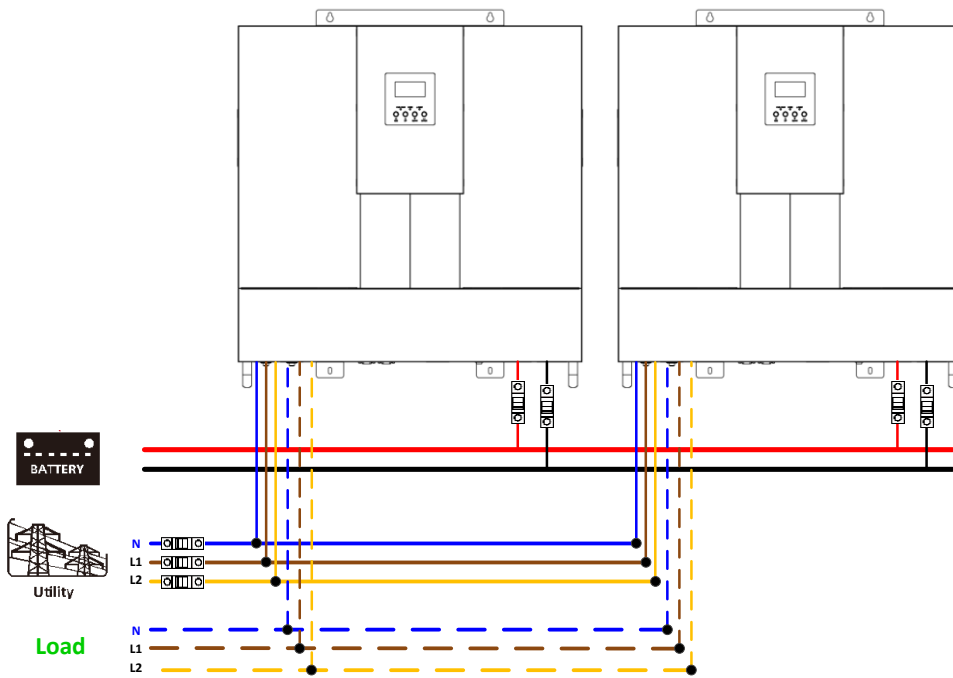

Communication Connection

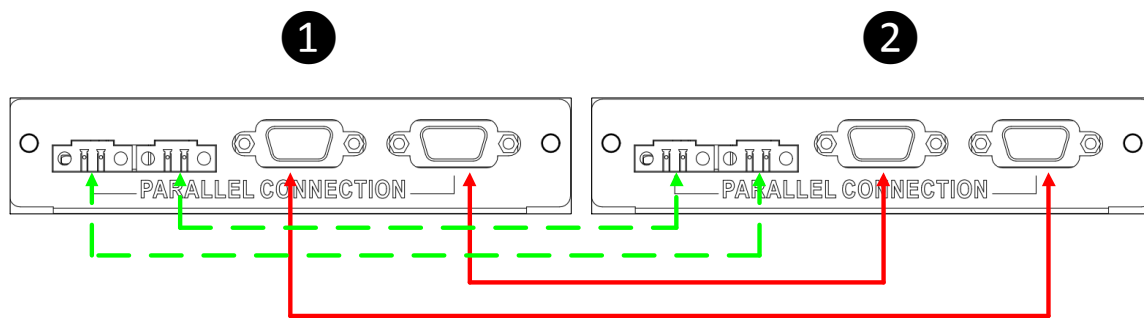

Three inverters in parallel (Line to Line output voltage is 208V):

Power Connection

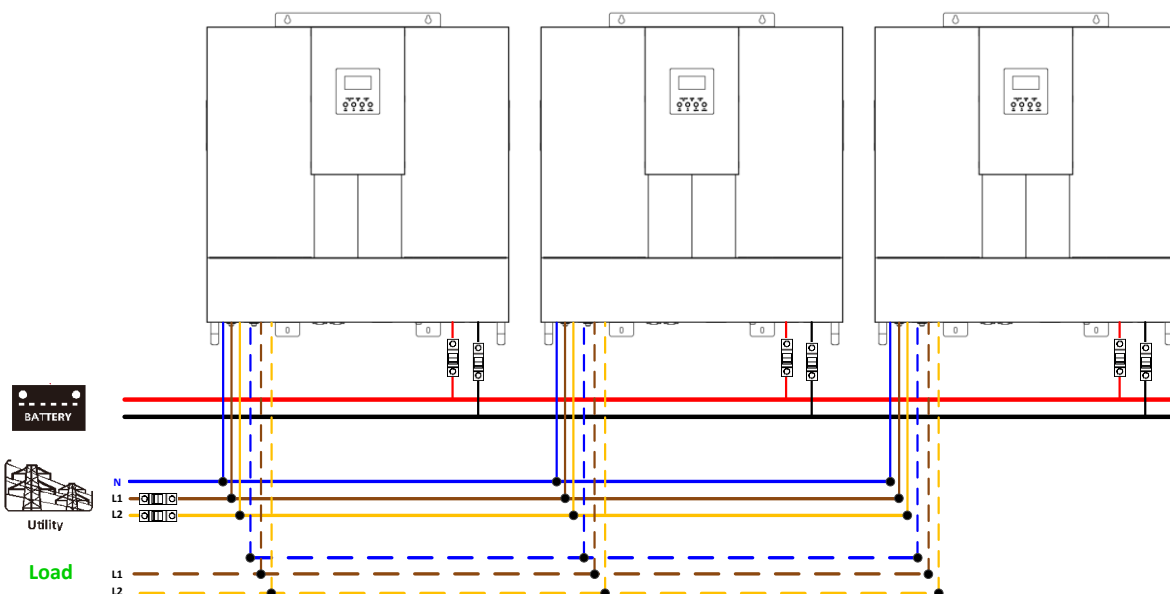

Communication Connection

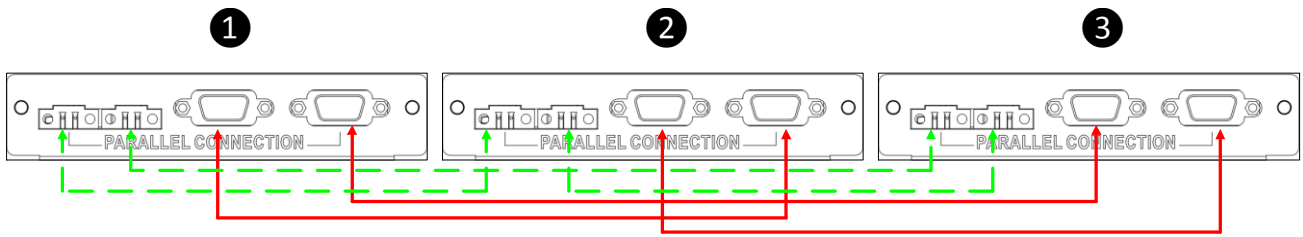

Three inverters in parallel (Line to Line output voltage is 240V):

Power Connection

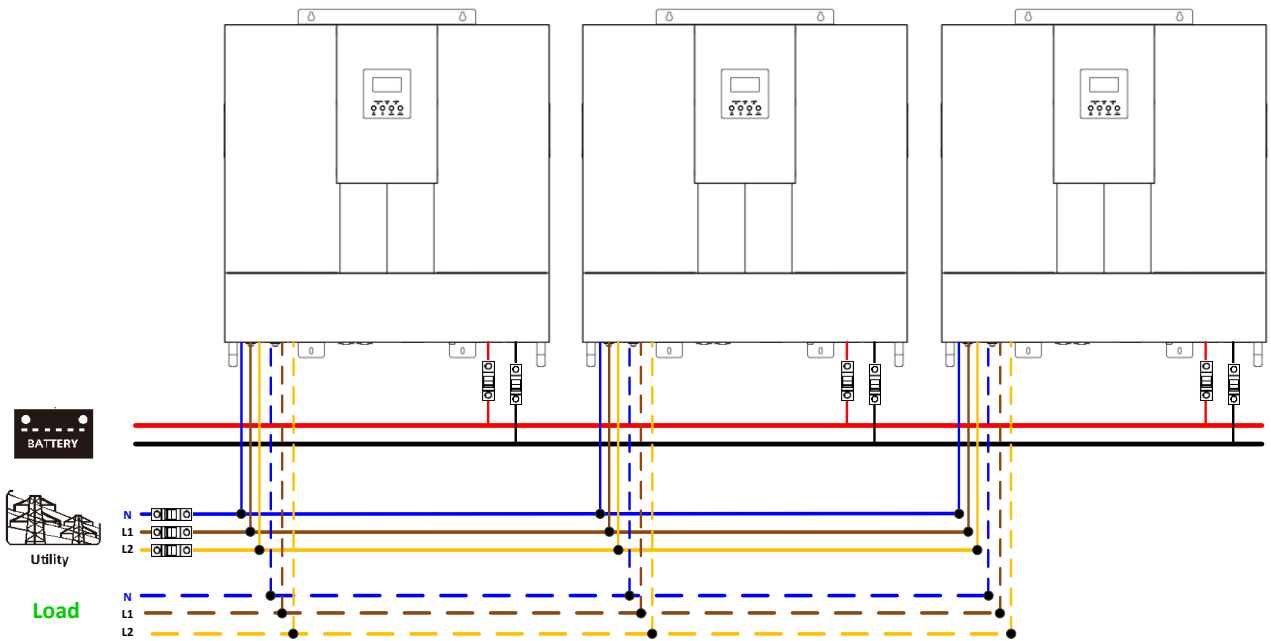

Communication Connection

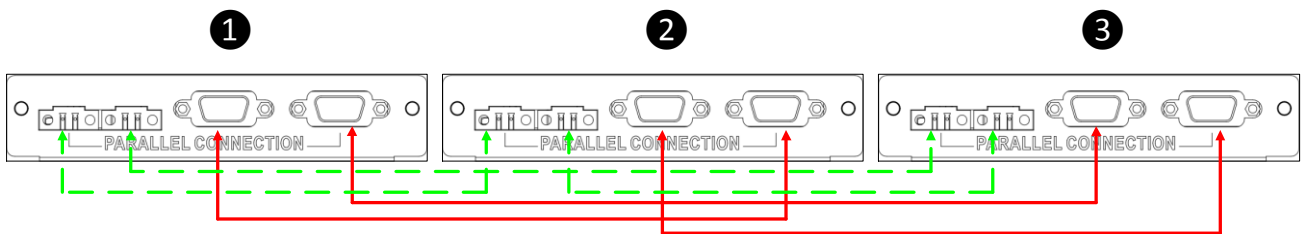

4-3. Support 3-phase equipment

One inverter in each phase:

Power Connection

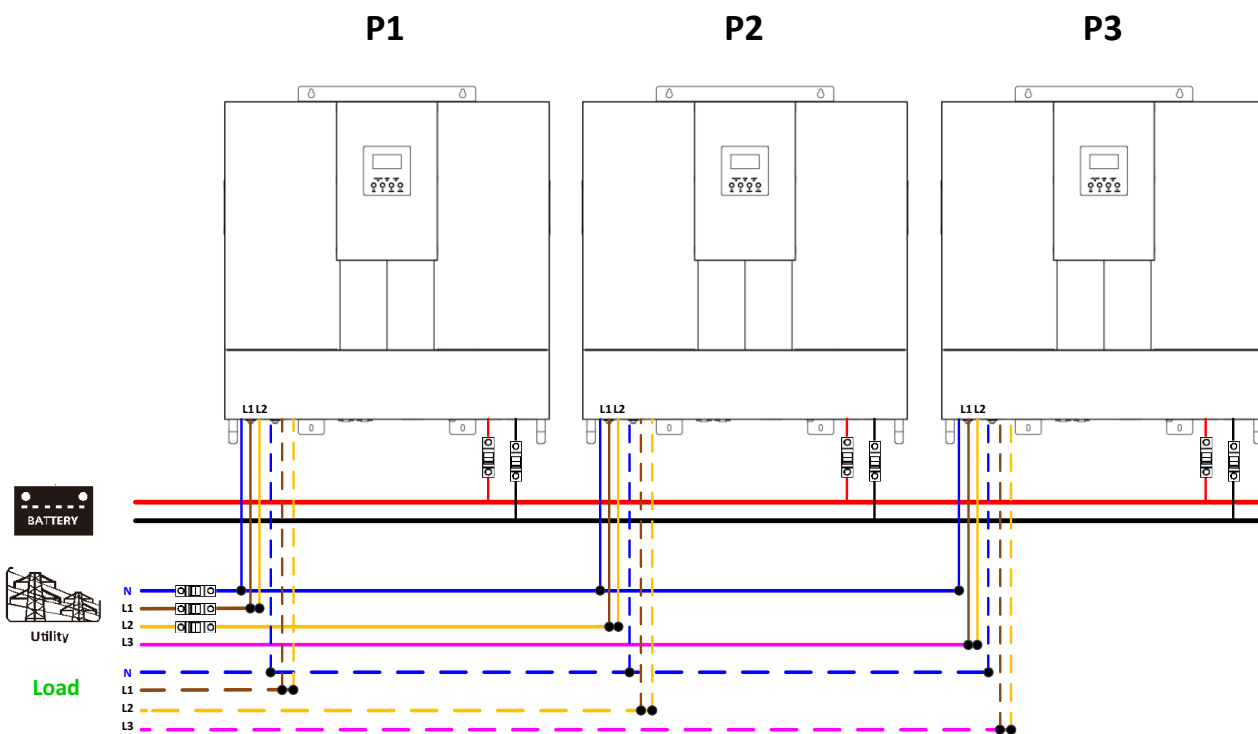

Communication Connection

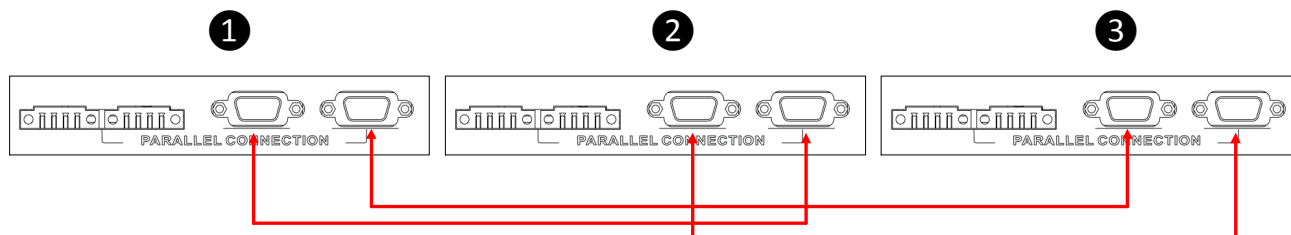

WARNING: Do NOT connect the current sharing cables between the inverters in different phases. Otherwise, it may damage the inverters.

NOTE: For parallel model operation, please refer to LCD program 28

5. PV Connection

Please refer to the user manual of single unit for PV Connection.

CAUTION: Each inverter should connect to PV modules separately.

6. Parallel ID Setting

It's necessary to set up parallel ID for each inverter.

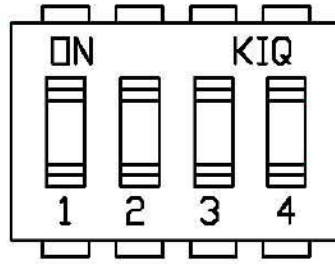









1	2	3	4	Parallel ID
OFF	OFF	OFF	*	0
ON	OFF	OFF	*	1
OFF	ON	OFF	*	2
ON	ON	OFF	*	3
OFF	OFF	ON	*	4
ON	OFF	ON	*	5
OFF	ON	ON	*	6
ON	ON	ON	*	7

* Not used











7. LCD Setting and Display

Setting Program:

Program	Description	Selectable option	
28	AC output mode *This setting is only available when the inverter is in standby mode (Switch off).	<p>Parallel output in single phase. Output voltage is 120V.</p> 	<p>When the units are used in parallel for single phase application, please select "2A0" in program 28. L1 to L2 output voltage is 0V and L to N output voltage is 120V. Please refers to 4-1 for detailed wiring.</p>
		<p>Support L1 phase output on 3-Phase application. Output voltage is 120V.</p> 	<p>It is required to have at least 3 inverters to support three-phase equipment. It's required to have at least one inverter in each phase or it's up to four inverters in one phase. Please refers to 4-3 for detailed information.</p> <p>Please select "3P1" in program 28 for the inverters connected to L1 phase, "3P2" in program 28 for the inverters connected to L2 phase and "3P3" in program 28 for the inverters connected to L3 phase.</p> <p>Be sure to connect shared current cables to units in the same phase. Do NOT connect shared current cables between units in different phases.</p>
		<p>Support L2 phase output on 3-Phase application. Output voltage is 120V.</p> 	
		<p>Support L3 phase output on 3-Phase application. Output voltage is 120V.</p> 	
		<p>Support L1/L2 phase output on split phase application with L1 to L2 output voltage in 208V.</p> 	<p>When the units are used in parallel for split phase application, please select "2A1" or "2A2" in program 28. When "2A1" is selected, L1 to L2 output voltage is 208V and L to N output voltage is 120V. When "2A2" is selected, L1 to L2 output voltage is 240V and L to N output voltage is 120V. Please refers to 4-2 for detailed wiring.</p>
		<p>Support L1/L2 phase output on split phase application with L1 to L2 output voltage in 240V.</p> 	

30	PV judge condition (Only apply for setting "Solar first" in program 1: Output source priority)	One Inverter (Default): 	When "ONE" is selected, as long as one of the inverters has been connected to PV modules and PV input is normal, parallel or 3-phase system will continue working according to rule of "solar first" setting. For example, two units are connected in parallel and set "SOL" in output source priority. If one of the two units has connected to PV modules and PV input is normal, the parallel system will provide power to loads from solar or battery power. If both of them are not sufficient, the system will provide power to loads from utility.
		All of Inverters: 	When "ALL" is selected, parallel or 3-phase system will continue working according to rule of "solar first" setting only when all of inverters are connected to PV modules. For example, two units are connected in parallel and set "SOL" in output source priority. When "ALL" is selected in program 30, it's necessary to have all inverters connected to PV modules and PV input is normal to allow the system to provide power to loads from solar and battery power. Otherwise, the system will provide power to loads from utility.

Fault code:

Fault Code	Fault Event	Icon on
60	Power feedback protection	
71	Firmware version inconsistent	
72	Current sharing fault	
80	CAN fault	
81	Host loss	
82	Synchronization loss	
83	Battery voltage detected different	
84	Different AC input voltage and frequency detected	
85	AC output current unbalance	
86	AC output mode setting is different	

8. Commissioning

Parallel in single phase

Step 1: Check the following requirements before installation:

- Correct wire connection
- Ensure all breakers in Line wires at load side are open and each Neutral wires of each unit is connected together.

Step 2: Turn on all of the units and configure LCD program 28 as **2A0**. And then shut down all units.

NOTE: It's necessary to turn off switch when setting LCD program. Otherwise, the setting cannot be programmed. **All the units must use same selection.**

Step 3: Turn on each unit.

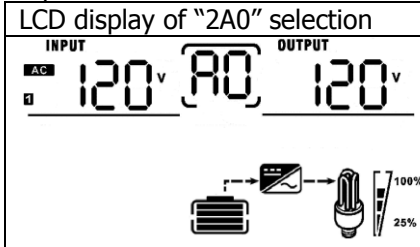

Step 4: Switch on all AC breakers of Line wires in AC input. It's better to connect all of the inverters to the utility at the same time. If not, it will display fault 82 in the following inverters. However, these inverters will automatically restart. If detecting AC connection, they will work normally.

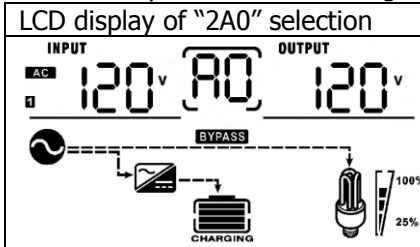

Step 5: If there is no more fault alarm, the parallel system is completely installed.

Step 6: Please switch on all breakers of Line wires in load side. This system will start to provide power to the load.

Parallel in split phase

Step 1: Check the following requirements before installation:

- Correct wire connection
- Ensure all breakers in Line wires at load side are open and each Neutral wires of each unit is connected together.

Step 2: Turn on all of the units and configure LCD program 28 as **2A1** or **2A2**. And then shut down all units.

NOTE: It's necessary to turn off switch when setting LCD program. Otherwise, the setting cannot be programmed. **All the units must use same selection.**

Step 3: Turn on each unit.

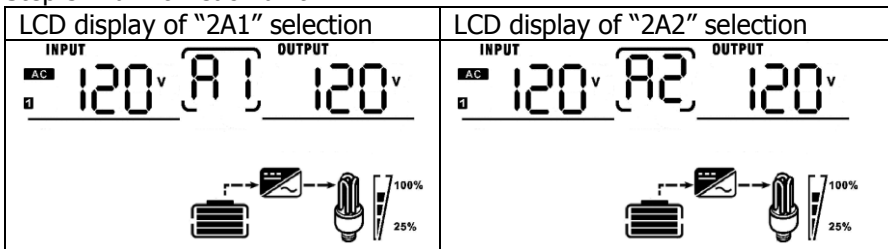

Step 4: Switch on all AC breakers of Line wires in AC input. It's better to connect all of the inverters to the utility at the same time. If not, it will display fault 82 in the following inverters. However, these inverters will automatically restart. If detecting AC connection, they will work normally.

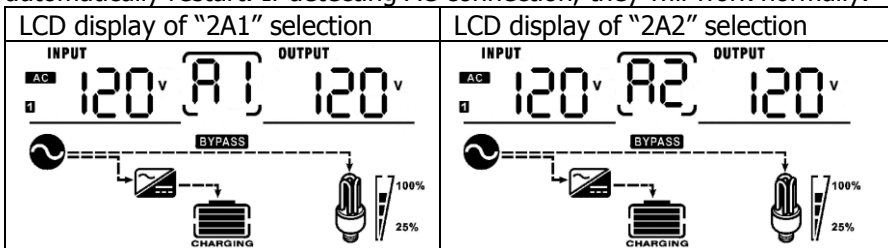

Step 5: If there is no more fault alarm, the parallel system is completely installed.

Step 6: Please switch on all breakers of Line wires in load side. This system will start to provide power to the load.

Support three-phase equipment

Step 1: Check the following requirements before installation:

- Correct wire connection
- Ensure all breakers in Line wires at load side are open and each Neutral wires of each unit is connected together.

Step 2: Turn on all of the units and configure LCD program 28 as 3P1, 3P2 and 3P3 sequentially. And then shut down all units.

NOTE: It's necessary to turn off switch when setting LCD program. Otherwise, the setting cannot be programmed.

Step 3: Turn on all units sequentially.

LCD display in L1-phase unit	LCD display in L2-phase unit	LCD display in L3-phase unit

Step 4: Switch on all AC breakers of Line wires in AC input. If AC connection is detected and three phases are matched with unit setting, they will work normally. Otherwise, the AC icon will flash and they will not work in line mode. Under this circumstance, you can switch wires of AC inputs from L2 phase and L3 phase. Or you may exchange the LCD program 28 of P2 and P3 to solve this problem.

LCD display in L1-phase unit	LCD display in L2-phase unit	LCD display in L3-phase unit

Step 5: If there is no more fault alarm, the system to support 3-phase equipment is completely installed.

Step 6: Please switch on all breakers of Line wires in load side. This system will start to provide power to the load.

Note 1: To avoid overload occurring, before turning on breakers at load side, it's better to have the whole system in operation first.

Note 2: There is some transfer time for this operation. Power interruption may happen to critical devices, which cannot tolerate transfer time.

9. Troubleshooting

If the device fails to function as expected, check the list of common faults below before consulting the service center.

Situation		Solution
Fault Code	Fault Event Description	
60	Current feedback into the inverter is detected.	<ol style="list-style-type: none"> Restart the inverter. Check if L/N cables are not connected reversely in all inverters. For parallel system in single phase, make sure the current sharing cables are connected to all inverters. For supporting three-phase system, make sure the current sharing cables are connected to the inverters in the same phase, and disconnected to the inverters in different phases. If the problem remains, please contact your installer.
71	The firmware version of each inverter is not the same.	<ol style="list-style-type: none"> Update the firmware of all inverter to the same version. Check the version of each inverter via LCD setting and make sure the CPU versions are the same. If not, please contact your installer to provide the latest firmware to update. After updating, if the problem still remains, please contact your installer.
72	The output current of each inverter is different.	<ol style="list-style-type: none"> Check if shared cables are connected well and restart the inverter. If the problem remains, please contact your installer.
80	CAN data loss	<ol style="list-style-type: none"> Check if communication cables are connected well and restart the inverter. If the problem remains, please contact your installer.
81	Host data loss	
82	Synchronization data loss	
83	The battery voltage of each inverter is not the same.	<ol style="list-style-type: none"> Make sure all inverters share the same groups of batteries together. Remove all loads and disconnect AC input and PV input. Then, check battery voltage of all inverters. If the values from all inverters are close, please check if all battery cables are in the same length and in the same material type. Otherwise, please contact your installer to provide SOP to calibrate battery voltage of each inverter. If the problem still remains, please contact your installer.
84	AC input voltage and frequency are detected different.	<ol style="list-style-type: none"> Check the utility wiring connection and restart the inverter. Make sure utility starts up at same time. If there are breakers installed between utility and inverters, please be sure all AC input breakers can be turned on at same time. If the problem remains, please contact your installer.
85	AC output current unbalance	<ol style="list-style-type: none"> Restart the inverter. Remove some excessive loads and re-check the load information from LCD of the inverters. If the values are different, please check if AC input and output cables are in the same length and in the same material type. If the problem remains, please contact your installer.
86	AC output mode setting is different.	<ol style="list-style-type: none"> Switch off the inverter and check LCD setting #28. For parallel system in single phase application, make sure no 2A1, 2A2, 3P1, 3P2 or 3P3 is set on #28. For parallel system in split phase application, make sure no 2A0, 3P1, 3P2 or 3P3 is set on #28. Check #28 LCD setting section for the correct output voltage setting. For supporting three-phase system, make sure no 2A0, 2A1 or 2A2 is set on #28. If the problem remains, please contact your installer.